

# Instrument Catalogue



# CONTENTS

## Spinal

Anterior Cervical Plating System CanACP.....	1
Anterior Cervical Plating System CanACCESS.....	2
Posterior Thoracolumbar System CanFIX.....	3
Posterior Thoracolumbar System CanART.....	4
Posterior Thoracolumbar Universal Instruments Set.....	5
CanTSP5.5 Instruments Set.....	6
CanTSP5.5 Instruments Set for Correction.....	7
Posterior Thoracolumbar Fixation System CanTLF.....	8
Posterior Lumbar Interbody Fusion System CanPEEK-P.....	9
Transforaminal Lumbar Interbody Fusion System CanPEEK-T.....	10

## Trauma

Mini Fragment Plating System CanMLP.....	11
Ø2.4 Ø2.7 Locking Screw Instrument Set.....	12
Small Fragment Plating System CanSFP/CanSLP.....	13
Large Fragment Plating System CanLFP/CanLLP.....	14
Trauma Universal Instrument Set.....	15
HB3.0 Cannulated Screw System CanNUS.....	16
HB4.5Cannulated Screw System CanNUS.....	17
HB6.5/7.3Cannulated Screw System CanNUS.....	18
Proximal Femoral Nail System CanPFN.....	19
Proximal Femoral Nail System CanEFN.....	21
Tibia Nail System CanTN.....	23
Tibia Nail System CanETN.....	24
Sternoclavicular Hook System CanSHS.....	26
Less Invasive Stabilization System Instruments set CanLISS.....	27
Dynamic Hip and Condylar System CanDHS / CanDCS.....	28
Pelvis Reconstruction System CanPRS.....	29
Screw Extract Instrument set CanSES.....	30
Dynamic Reaming Instrument Set.....	31



# Anterior Cervical Plating System CanACP 211019000

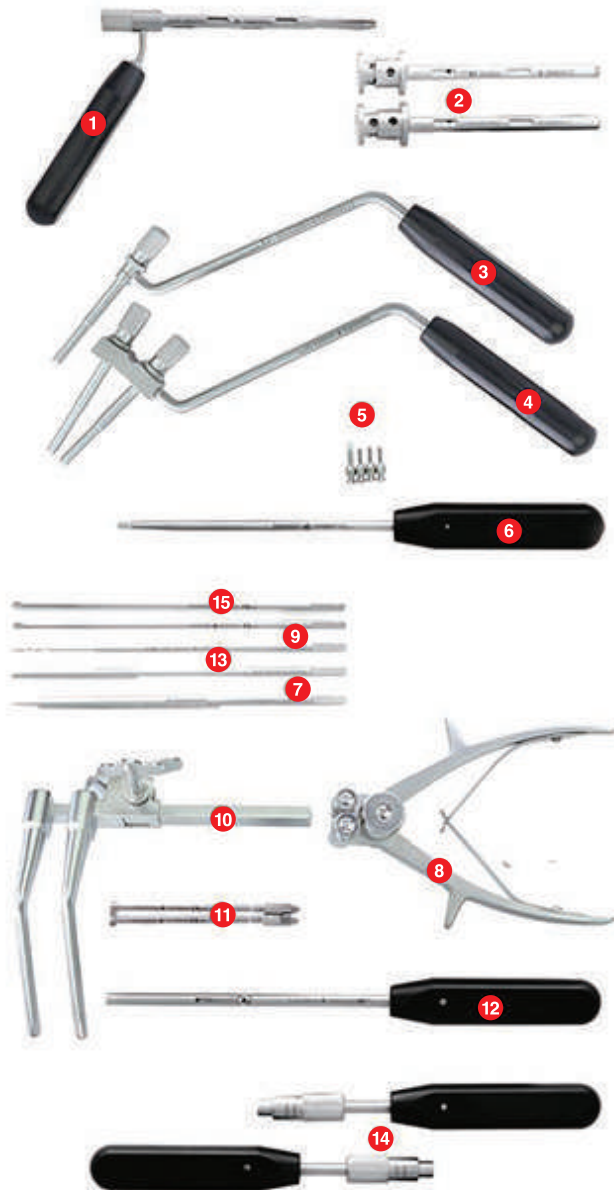
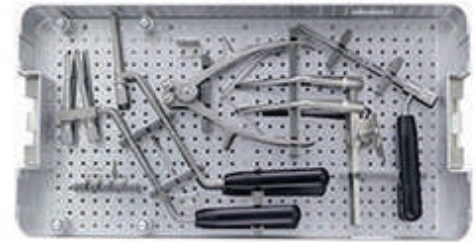
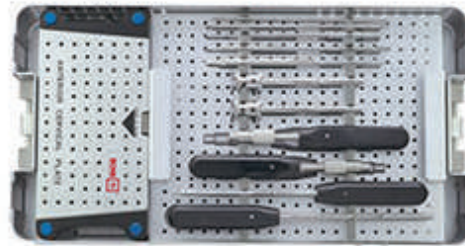

Number	P.N	Name	Quantity
1	211010001	Plate Holder	1
2	211010002	Screw Holder	2
3	211010003	Drill Guide, single barrel	1
4	211010004	Drill Guide, double barrel	1
5	211010005	Plate Holding Pin	4
6	211010007	Lock Screw Driver	1
7	211010008	Tap for 3,5mm Cortex Screw Thread Length 25mm	1
8	211010009	Drill Bit	1
9	211010010	Drill Bit, Ø2.0mm Thread Length 40mm	1
10	211010011	Distraction Pin	1
11	211010012	Distraction Pin Thread Length 14mm	2
12	211010013	Screwdriver for Distraction Pin	1
13	211010014	Awl	1
14	211010015	T-Handle with Quick Coupling	2
15	211010017	Screwdriver, Phillips	2
16	211013000	Instruments Tray	1
17	211014000	Implants Tray	1

# Anterior Cervical Plating System CanACCESS 211039000

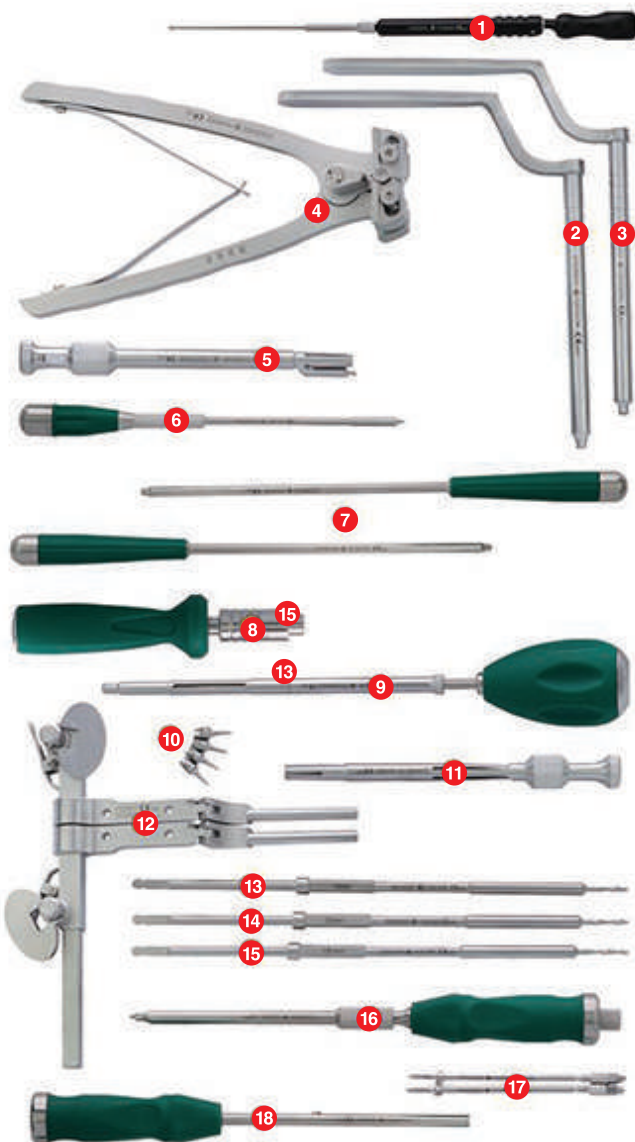
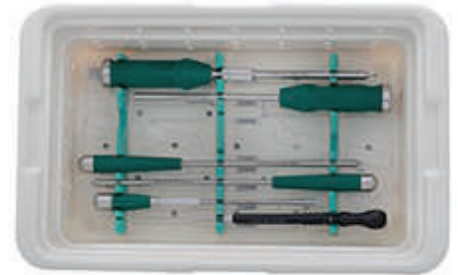
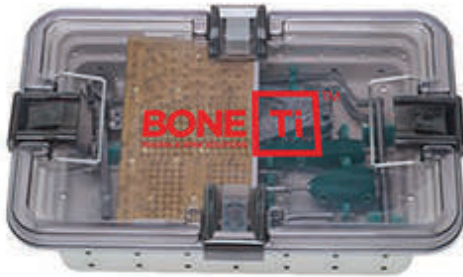

Number	P.N	Name	Quantity
1	212040012	Depth Gauge	1
2	211030001	Drill Guide, Fixed-Angle	1
3	211030002	Drill Guide, Variable-Angle	1
4	211030003	Cervical Plate Bender	1
5	211030004	Drill, Tap and Screw Guide	1
6	211030005	Screw head Cleaning	1
7	211030006	Screwdriver	2
8	211030007	Quick Coupling Handle	1
9	211030008	Awl(variable angle)	1
10	211030009	Temporary Fixation Pin	4
11	211030010	Holding Sleeve	1
12	211030011	Adjustable Cervical Distractor	1
13	211030012	2.5mm Drill Bit, Head length 14mm	1
14	211030013	2.5mm Drill Bit, Head length 16mm	1
15	211030014	2.5mm Drill Bit, Head length 18mm	1
16	211030015	Extraction Screwdriver	1
17	211030016	Distraction Pin	2
18	211030017	Screwdriver for Distraction Pin	1
20	211032000	Implants-Tray	1
21	211031000	Instruments-Tray	1



# Posterior Thoracolumbar System CanFIX 212019000

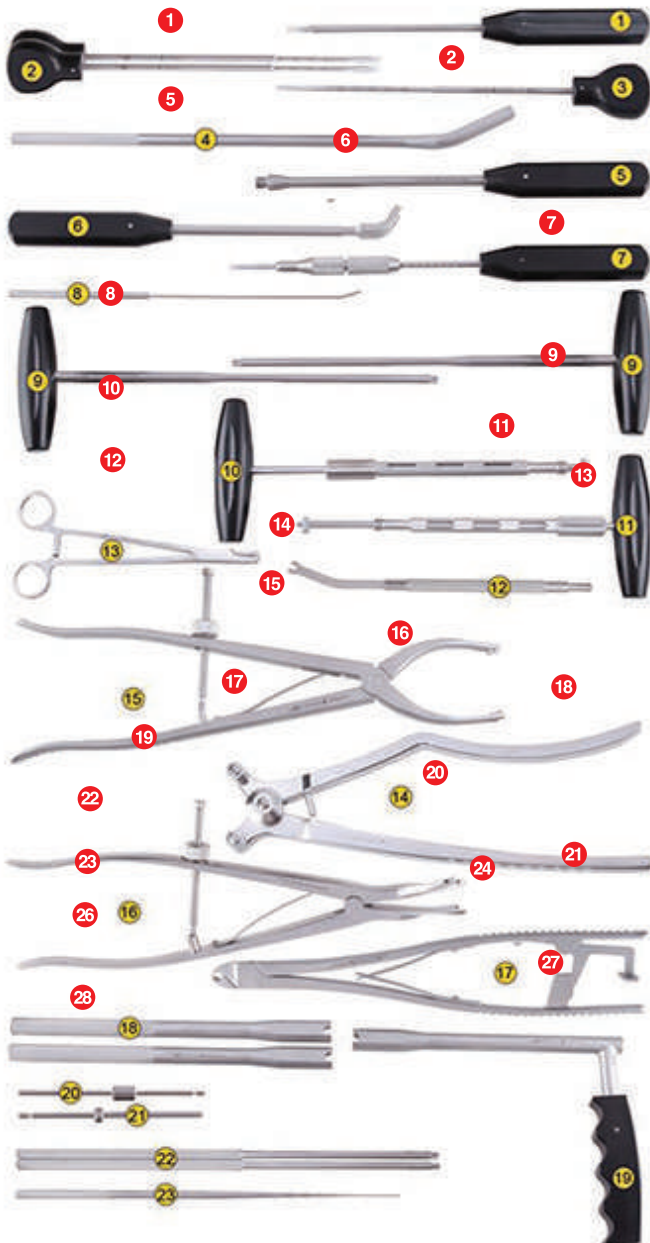
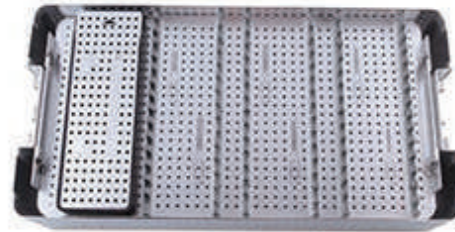

Number	P.N	Name	Quantity
1	212010001	Awl Length 228mm	1
2	212010002	Pedicle Probe, $\phi$ 3.0mm	1
3	212010003	Pedicle Probe, $\phi$ 3.5mm	1
4	212010004	Screw Tab Breaker	1
5	212010006	Universal Screw Drive	1
6	212010007	Rod Pusher	1
7	212010008	Depth-limited Awl	1
8	212010009	Feeler for Screw Channel, curved Length 225mm	1
9	212010010	Plug Driver, with T-handle	2
10	212010011	Monoaxial Screwdriver	1
11	212010012	Polyaxial Screwdriver	1
12	212010013	Rod Rotation Wrench, hexagonal	1
13	212010014	Rod Holder	1
14	212010015	Rod Bender Length 283mm	1
15	212010016	Compression Forceps, Length 338mm	1
16	212010017	Distraction Forceps Length 330mm	1
17	212010018	Power Grip, Length 293mm	1
18	212010019	Compression Sleeve Length 220mm	1
19	212010020	Counter Torque Wrench Length 230mm	2
20	212010021	Marker Insertor (cylindrical) Length 80mm	3
21	212010022	Marker Insertor (sphere) Length 80mm	3
22	212020004	Plug Starter	2
23	212030022	Feeler for Screw Channel, straight Length 225mm	1
24	212013000	Implant tray (CanFIX)	1
25	212012000	Instruments Tray	1

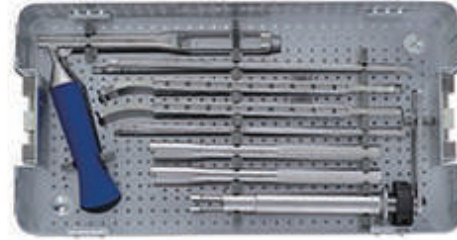
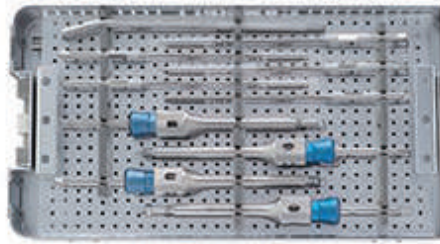

Number	P.N	Name	Quantity
1	212010019	Compression Sleeve	2
2	212020026	Reduction Forceps	1
3	212060012	In-situ Bender, left	1
4	212060013	In-situ Bender, right	1
5	212060015	Reduction Screw Tab Breaker	1
6	212060016	Tap(4.5mm)	1
7	212060017	Tap(5.0mm)	1
8	212060018	Tap(5.5mm)	1
9	212060019	Tap(6.0mm)	1
10	212060020	Tap(6.5mm)	1
11	212060023	Plug Driver	19
12	212060024	Monoaxial Screwdriver	1
13	212060025	Reduction Monoaxial Screwdriver	1
14	212060026	Polyaxial Screwdriver	1
15	212060027	Reduction Polyaxial Screwdrive	1
16	212060028	Counter Torque Wrench	1
17	212010035	Plug Starter	2
18	212057900	Universal Spinal Screw Tray	1
20	212121000	CanART Instruments Tray	1



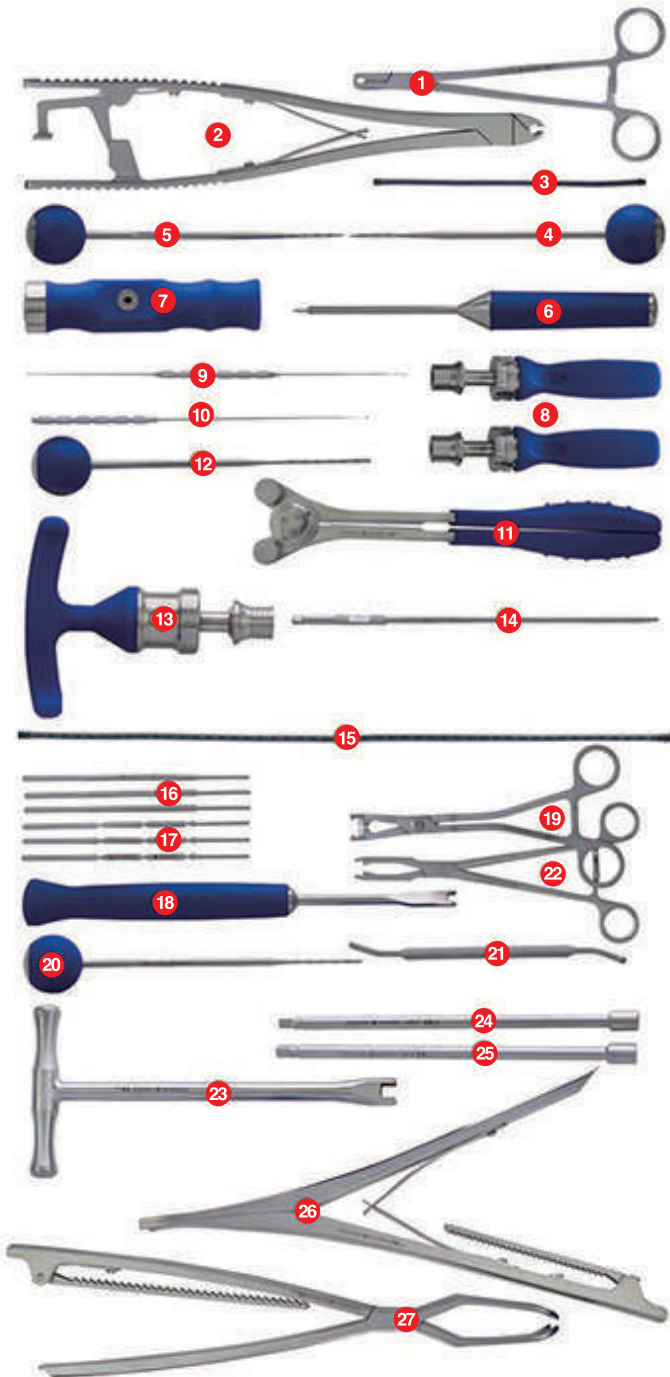
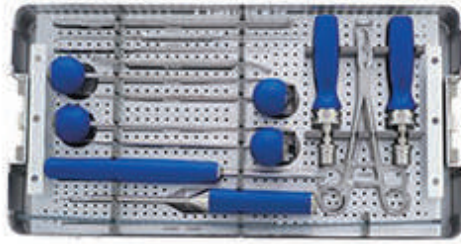

Number	P.N	Name	Quantity
1	212010014	Rod Holder	1
2	212010018	Power Grip	2
3	212020029	Rod Template Length 210mm	1
4	212050009	Thoracic Speed Shift	1
5	212050010	Lumbar Speed Shift	1
6	212050011	Awl	1
7	212050012	Quick Coupling T-handle	1
8	212050013	Quick Coupling Handle	2
9	212050019	Dual Sides Probe	1
10	212050020	Probe	1
11	212050043	Rod Bender	1
12	212050064	Awl with Palm Handle	1
13	212050025	Torque Limiter( 12N.M)	1
14	212050050	Crosslink Set Driver(SW3.5)	1
15	212050052	Rod Template(500mm)	1
16	212050055	Marker Inserter(Left)	3
17	212050054	Marker Inserter(Right)	3
18	212060005	C-shaped Rod Pusher	1
19	212121000	Rod Pusher(6.0mm)	1
20	212050045	Awl with Palm Handle	1
21	212050057	Dual End Rod Rotation Wrench	1
22	212050058	Crosslink Holder	1
23	212050059	Countertorque, for crosslink	1
24	212050060	SW5.5 Crosslink Nut Driver	1
25	212050061	SW8 Crosslink Nut Driver	1
26	212050062	Parallel Distraction Forceps	1
27	212050063	Parallel Compression Forceps	1
28	212071000	Instruments Tray	1

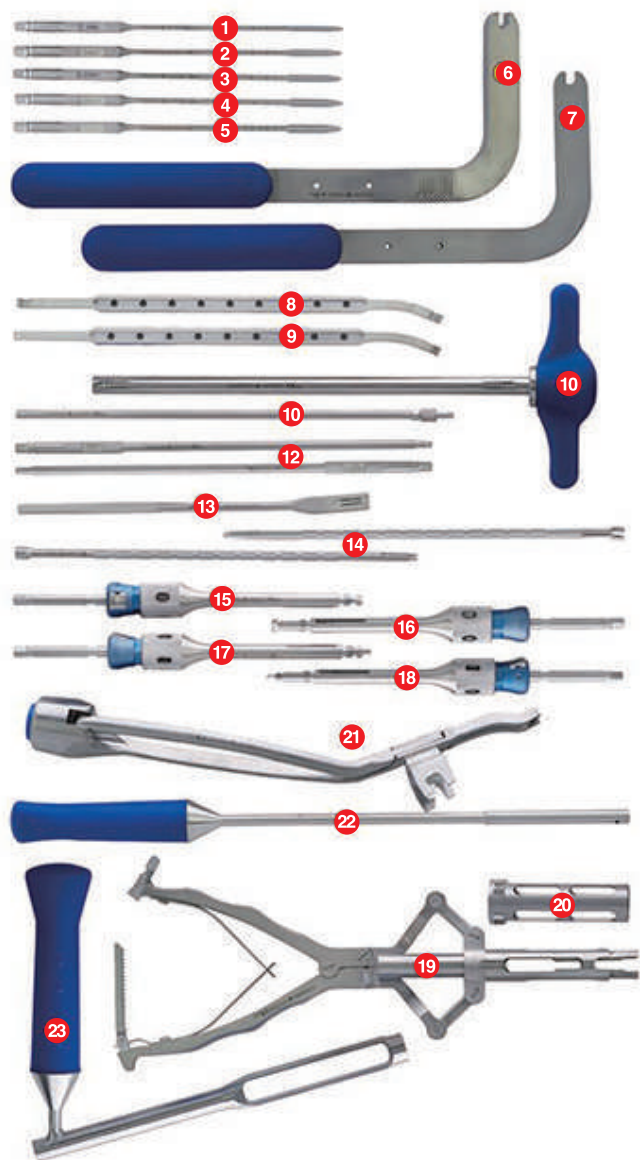
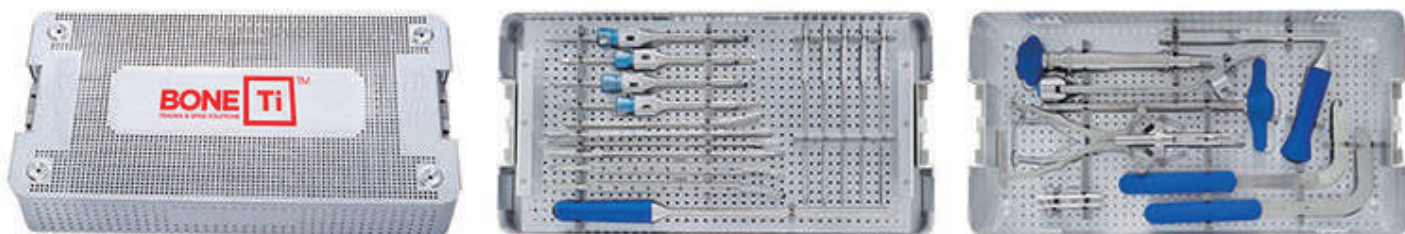

Number	P.N	Name	Quantity
1	212050014	Tap(4.5mm)	1
2	212050015	Tap(5.0mm)	1
3	212050016	Tap(5.5mm)	1
4	212050017	Tap(6.0mm)	1
5	212050018	Tap(6.5mm)	1
6	212050031	Rod Bender, left	1
7	212050032	Rod Bender, right	1
8	212050033	In-situ Bender, left	1
9	212050034	In-situ Bender, right	1
10	212050037	Self-retaining Break-off Driver	1
11	212050038	Stardrive screwdriver	1
12	212050039	Quick Coupling Plug driver	2
13	212050048	Reduction Screw Tab Breaker	1
14	212050949	Dual End Plug Starter(short)	2
15	212050060	Monoaxial Screwdriver	1
16	212050061	Reduction Monoaxial Screwdriver	1
17	212050062	Polyaxial Screwdriver	1
18	212050063	Reduction Polyaxial Screwdrive	1
19	212050064	Reduction Forceps	1
20	212050065	Extender	1
21	212050066	Lateral Translator	1
22	212050067	Plug Starter	1
23	212050068	Counter Torque Wrench	1
24	212057900	Universal Spinal Screw Tray	1
25	212151000	Instruments tray(TSP5.5)	1



# CanTSP5.5 Instruments Set for Correction 212259000

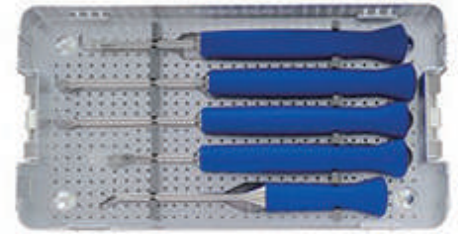
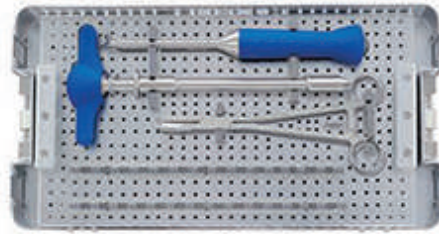

Number	P.N	Name	Quantity
1	212050001	Wide blade Lamina Elevator	1
2	212050002	Narrow blade Lamina Elevator	1
3	212050003	Pedicle Elevator	1
4	212050004	Transverse Process Elevator	1
5	212050005	Hook Pusher for Implant Holder	1
6	212050006	Implant Pusher for Dual Purpose Instrument	1
7	212050007	Lateral Implant Holder	2
8	212050008	Dual Purpose Instrument	1
9	212078000	Instruments tray(TSP5.5 Correction)	1
10	212071000	Universal Spinal Screw Tray	1



Number	P.N	Name	Quantity
1	212010014	Rod Holder	1
2	212010018	Power Grip.Length 293mm	1
3	212010021	Marker Inserter(cylindrical)	3
4	212010022	Marker Inserter(sphere)	3
5	212020029	Rod Template Length 210mm	1
6	212020013	Rod Bender Length 283mm	1
7	212020014	Parallel Distraction Forceps	1
8	212020015	Parallel Compression Forceps	1
9	212020018	Pedicle Marker Inserter	1
10	212020024	Awl.Length 227mm	1
11	212040001	Ø2.8 Pedicle Probe	1
12	212040002	Ø3.8 Pedicle Probe	1
13	212040003	T-Handle	1
14	212040004	Post Break-off Wrench(large)	1
15	212040005	Post Break-off Wrench(small)	1
16	212040006	SW11 Socket Wrench	2
17	212040008	Screw Clamp	1
18	212040007	Bolt Cutting Head	1
19	212040011	Rod Pusher	1
20	212040012	Depth Gauge	1
21	212040013	Funnel for Cancellous Bone Graft	1
22	212040014	Cancellous Bone Impactor(straight)	1
23	212040015	Cancellous Bone Impactor(bent)	1
24	212040016	Reduction Sleeve	2
25	212040017	Nut	2
26	212040018	SW8 Sleeve Wrench	1
27	212040019	Screwdriver for crosslink	1
28	212040020	SW6 Sleeve Wrench	1
29	212040021	Hook Holder	1
30	212042000	Instrument Tray	1
31	212030022	IFeeler for Screw Channel, straight Length 225mm	1



# Posterior Lumbar Interbody Fusion System CanPEEK-P™ 21332800

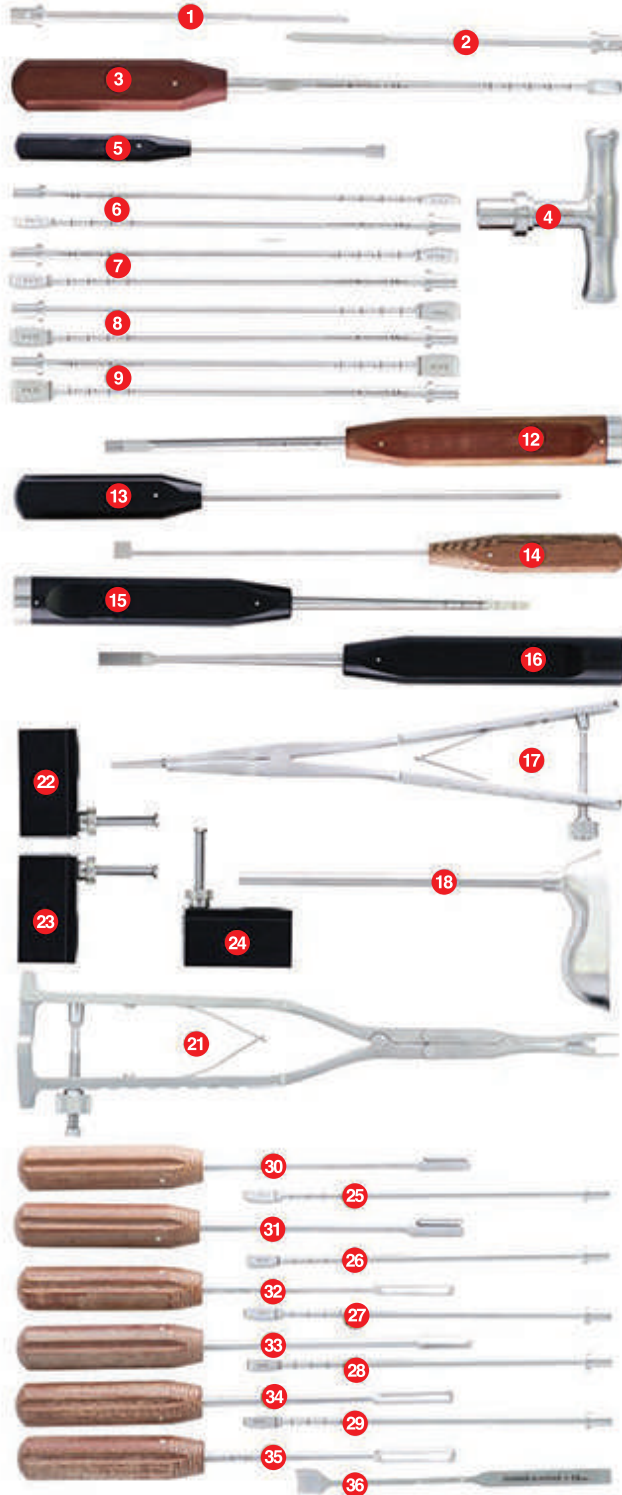
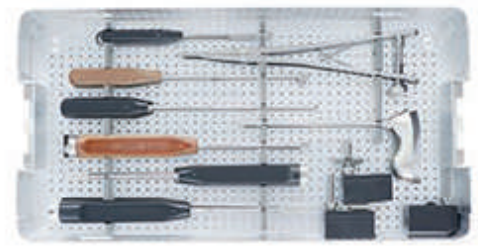
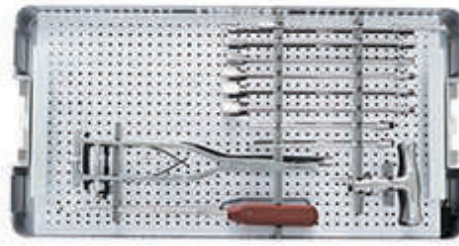

Number	P.N	Name	Quantity
1	213310001	Disc Space Opener, width 4mm, height 8mm	1
2	213310002	Disc Space Opener, width 5mm, height 9mm	1
3	213320001	Bone Curette, rectangular, straight, 8.0mm	1
4	213320002	T-Handle with Quick Coupling	1
5	213320003	Cancellous Bone Impactor, 8x2.5mm	1
6	213320005	Trial Implant, size 7mm	2
7	213320006	Trial Implant, size 9mm	2
8	213320007	Trial Implant, size 11mm	2
9	213320008	Trial Implant, size 13mm	2
12	213320011	Impactor for PLIF spacer	1
13	213320012	Bone graft pusher, Ø8.0mm, for use with Funnel	1
14	213320013	Bone-graft packer	1
15	213320015	Osteotome, 5mm	1
16	213320016	Bone Rasp, straight, 8mm	1
17	213320017	Distractor	1
18	213320018	Bone Graft funnel, Ø8.0mm, length 220mm	1
20	213323000	Instruments Tray	1
21	213320032	Implant Holder	1
22	213320029	Packing Block(width 8mm)	1
23	213320030	Packing Block(width 10mm)	1
24	213320031	Packing Block(width 12mm)	1
25	213320033	Trial Implant(8×24 9mm)	1
26	213320034	Trial Implant(10×22 9mm)	1
27	213320035	Trial Implant(10×24 9mm)	1
28	213320036	Trial Implant(12×22 9mm)	1
29	213320037	Trial Implant(12×24 9mm)	1
30	213320022	Cannulated Bone Curette (rectangular, Large)	1
31	213320023	Cannulated Bone Curette (rectangular, Middle)	1
32	213320024	Cannulated Bone Curette (rectangular, Small)	1
33	213320025	Cannulated Bone Curette (round, Large)	1
34	213320026	Cannulated Bone Curette (round, Middle)	1
35	213320027	Cannulated Bone Curette (round, Small)	1
36	213320028	Retractor	1



# Transforaminal Lumbar Interbody Fusion System CanPEEK-T™ 213419000

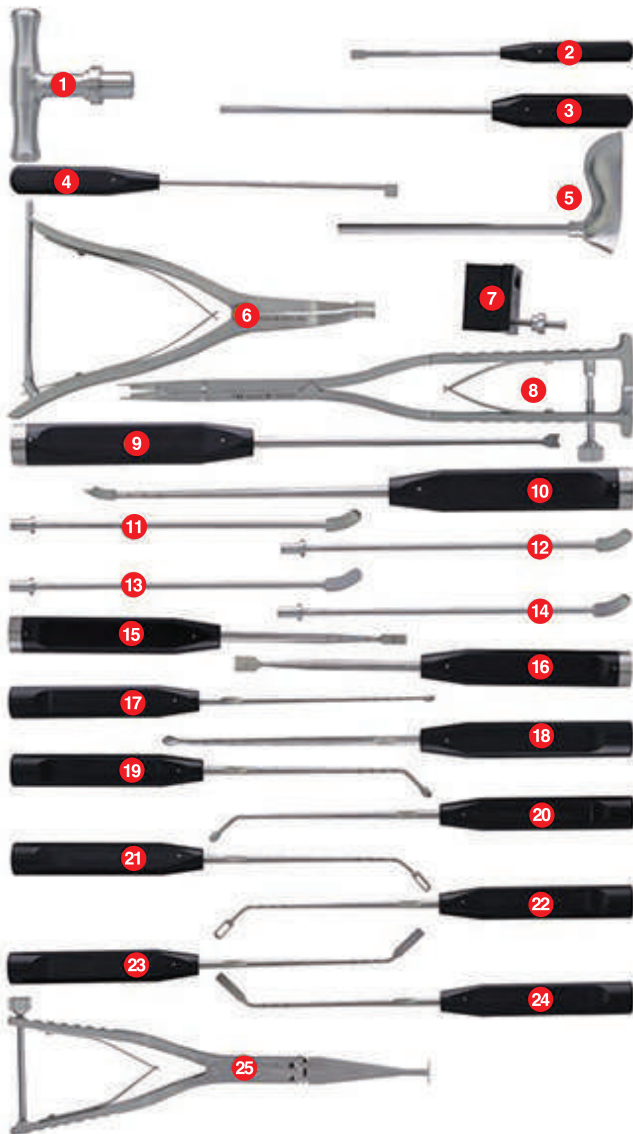

Number	P.N	Name	Quantity
1	213320002	T-Handle with Quick Coupling	1
2	213320003	Cancellous Bone Impactor, 8x2.5mm	1
3	213320012	Bone graft pusher, Ø8.0mm, for use with Funnel	1
4	213320013	Bone graft packer	1
5	213320018	Bone Graft funnel, Ø8.0mm, length 220mm	1
6	213410001	Lamina Spreader for CanPEEK-T	1
7	213410002	Packing Block for CanPEEK-T	1
8	213410003	Implant Holder for CanPEEK-T	1
9	213410004	Impactor, straight	1
10	213410005	Impactor, curved	1
11	213410006	Trial Implant, size 7mm	1
12	213410007	Trial Implant, size 9mm	1
13	213410008	Trial Implant, size 11mm	1
14	213410009	Trial Implant, size 13mm	1
15	213410012	Osteotome, straight, 8mm	1
16	213410013	Osteotome, straight, 12mm	1
17	213410014	Bone Curette, straight, 7.5mm	1
18	213410015	Reverse angle, Bone Curette, straight, 7.5mm	1
19	213410016	Bone Curette, right angled, 7.5mm	1
20	213410017	Bone Curette, left angled, 7.5mm	1
21	213410018	Bone Curette, rectangular, right, 8mm	1
22	213410019	Bone Curette, rectangular, left, 8mm	1
23	213410020	Bone Rasp, left, 8mm	1
24	213410021	Bone Rasp, right, 8mm	1
25	213410022	Distractor	1
26	213413000	Instrument Tray	1



# Mini Fragment Plating System CanMLP 111219900

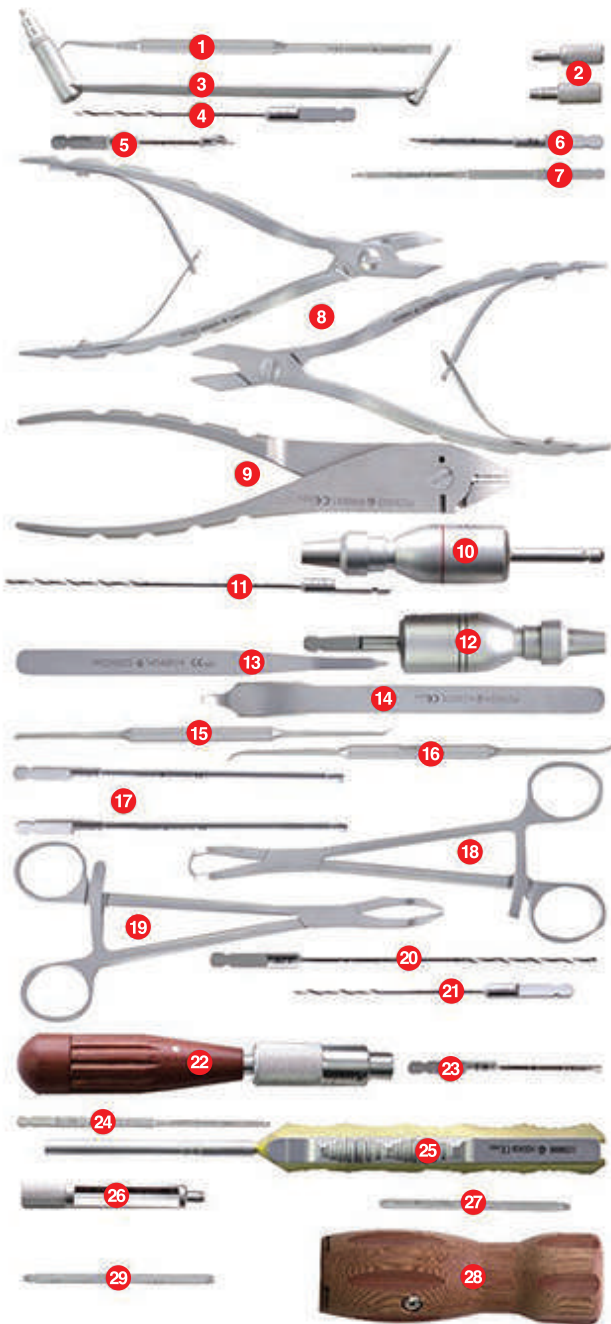

Number	P.N	Name	Quantity
1	113200021	Sharp Hook	1
2	111210002	LCP Drill Sleeve2.0	2
3	111210003	Drill Sleeve 2.0	1
4	111210004	Drill Bit (φ1.5)	2
5	111210006	Countersink	1
6	111210007	Stardrive screwdriver-2.0	1
7	111210008	Stardrive screwdriver shaft-2.0	1
8	111210012	Flat Pliers	2
9	111210013	Cutting Pliers	1
10	111210014	Torque Limiter 0.4Nm	1
12	111210022	Torque Limiter 0.6Nm	1
13	111210023	Retractor (small)	1
14	111210024	Retractor (large)	1
15	111210026	Periosteal Elevator(small)	1
16	111210027	Periosteal Elevator(large)	1
17	111110007	Phillips Screwdriver Shaft	2
18	111110008	Reduction Forceps, with point	1
19	111110009	Reduction Forceps, with serrated jaws	1
20	112300002	Ø1.8 Drill Bit	2
22	112300004	T-handle with Quick Coupling	1
23	112300005	Stardrive Screwdriver(short)	1
24	112300006	Stardrive Screwdriver(long)	1
25	112300008	Depth Gauge	1
26	112300009	Ø1.8 LCP Drill Sleeve	2
27	112300010	Universal Drill Guide	1
28	112300011	T-handle with Quick Coupling	1
29	111210031	LCP Plate Bender	2
30	111219400	Special Instruments Tray	1
31	111219500	Implants Tray	1
32	111219600	Instruments Tray	1

# Ø2.4 Ø2.7 Locking Screw Instrument Set

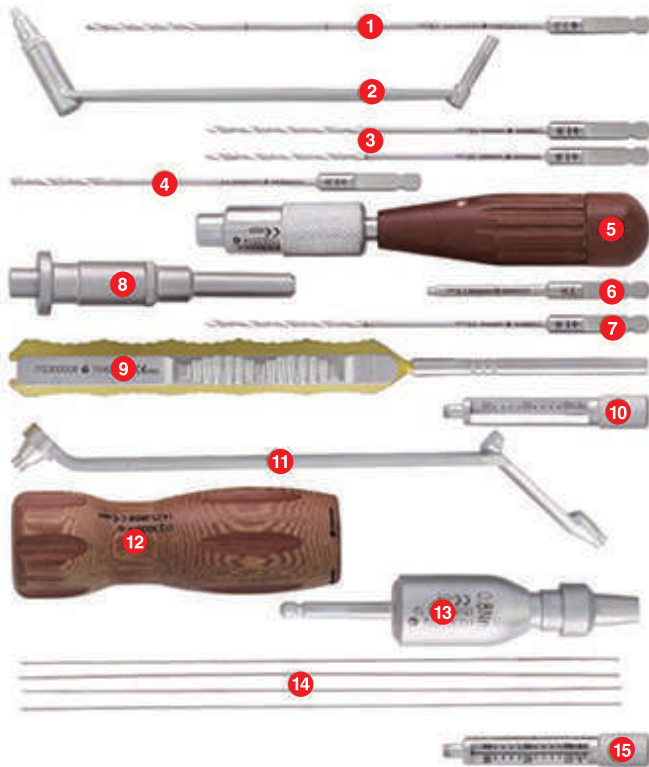
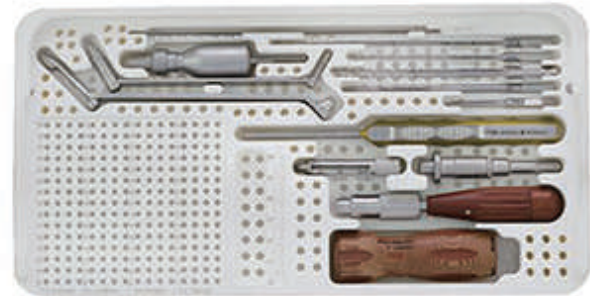

Number	P.N	Name	Quantity
1	112300015	Ø2.0 Drill Bit	1
2	112300001	Ø1.8-Ø2.4 Drill Sleeve	1
3	112300002	Ø1.8 Drill Bit	2
4	112300003	Ø2.0 Drill Bit	1
5	112300004	Straight Handle with Quick Coupling	1
6	112300005	Stardrive Screwdriver(short)	1
7	112300006	Stardrive Screwdriver(long)	1
8	112300007	Holding Sleeve	1
9	112300008	Depth Gauge	1
10	112300009	Ø1.8 LCP Drill Sleeve	1
11	112300010	Universal Drill Guide	1
12	112300011	T-handle with Quick Coupling	1
13	112300012	Torque Limited Head	1
14	112300013	Guide Wire	4
15	112300014	Ø2.0 LCP Drill Sleeve	1
16	112307000	Instruments Tray	1
17	112308000	Instruments Tray	1



# Small Fragment Plating System CanSFP/CanSLP 112109900

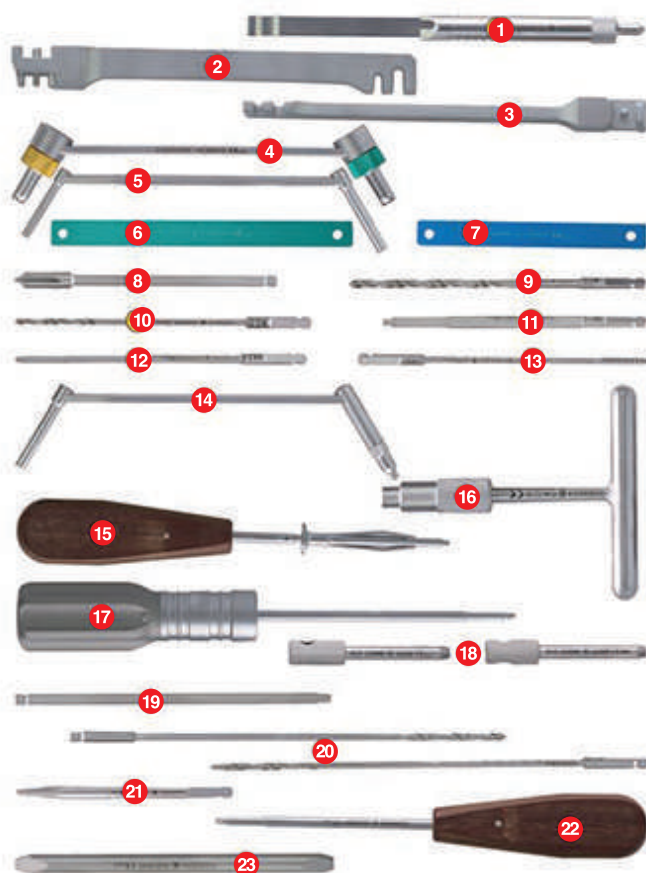
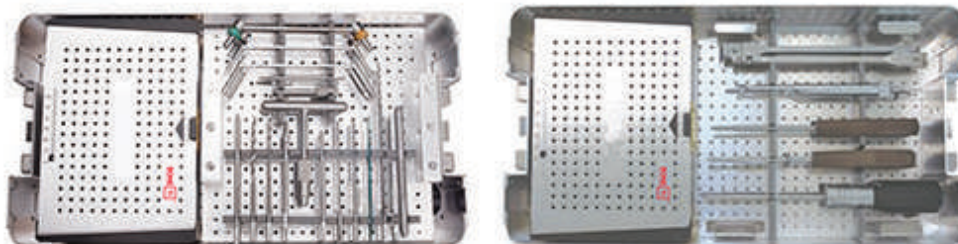

Number	P.N	Name	Quantity
1	112100001	Depth Gauge	1
2	112100002	Plate Bender, left Length 190mm	1
3	112100003	Plate Bender, right Length 190mm	1
4	112100004	LC-DCP Drill Guide	1
5	112100005	Double Drill Sleeve I	1
6	112100008	Bending Template, large Length 118mm Width 10mm	1
7	112100009	Bending Template, small Length 92mm Width 10mm	1
8	112100014	Countersink Length 100mm	1
9	112100015	Drill Bit, Ø3.5mm Length 112mm Thread Length 60mm	2
10	112100016	Drill Bit, Ø2.5mm Length 112mm Thread Length 30mm	1
11	112100017	Hexagonal Screwdriver Shaft	1
12	112100018	Tap for Cortex Screw ø3.5mm Length 112mm Thread Length 30mm	1
13	112100019	Tap for Cancellous Bone Screw ø4.0mm Thread Length 20mm	1
14	112100020	Universal Drill Guide II, Ø3.5/2.5mm	1
15	112100022	Hexagonal Screwdriver with Holding Sleeve, Length 200mm	1
16	112100024	T-handle with Quick Coupling Length 90mm	1
17	112200001	Torque Limiter 1.5N Length 220mm	1
18	112200002	ø2.6 Threaded Drill Sleeve for ø3.5mm	2
19	112200003	Stardrive Screwdriver Shaft, Length 120mm	1
20	112200004	ø2.6 Drill Bit Length 165mm Thread Length 40mm	2
21	112200005	Easyout Length 80mm	1
22	112200009	Screw Driver Length 200mm	1
23	112200010	Bender for K-Wire	1
24	112127000	Screw Tray	1
25	112128000	Instrument Tray	1



# Large Fragment Plating System

## CanLFP/CanLLP113119000

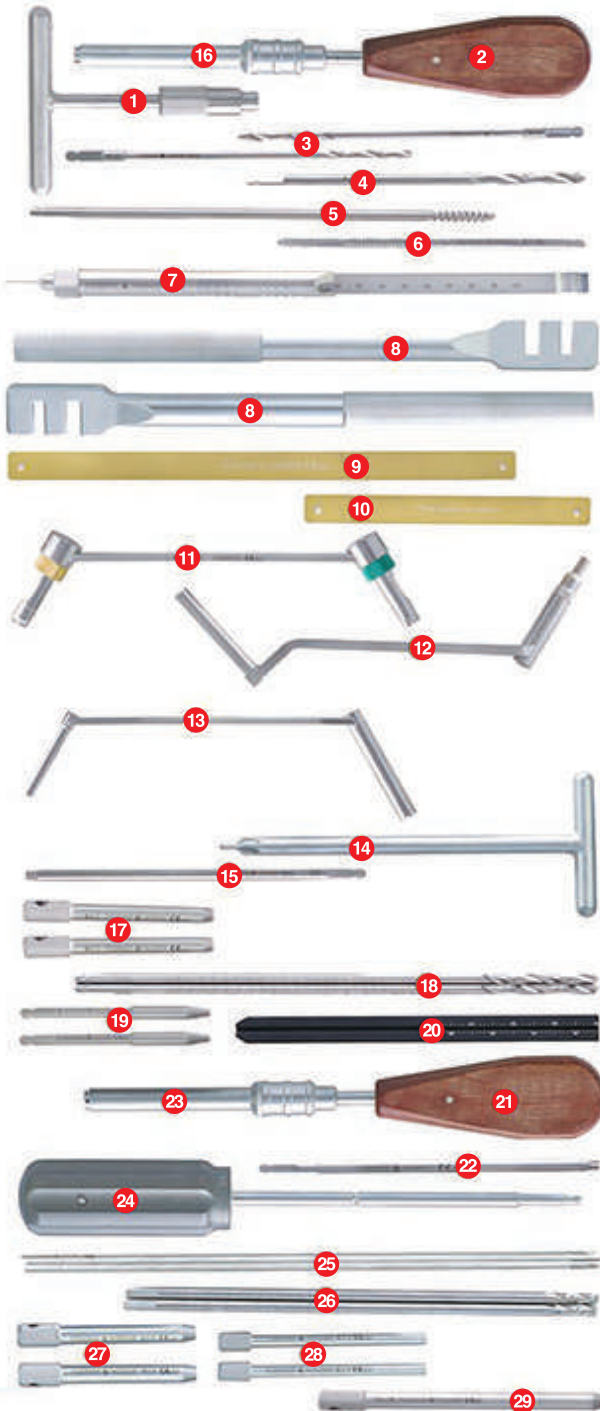
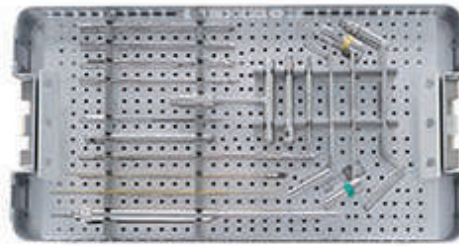

Number	P.N	Name	Quantity
1	112100024	T-handle with Quick Coupling Length 90mm	1
2	113100001	Hexagonal Screwdriver, Length 248mm	1
3	113100002	Drill Bit, $\phi$ 3.2mm Length 147mm Thread Length 40mm	2
4	113100003	Drill Bit, $\phi$ 4.5mm Length 145mm Thread Length 48mm	1
5	113100005	Tap for Cancellous Bone Screw $\phi$ 6.5mm Length 195mm Thread Length 26mm	1
6	113100006	Tap for Cortex Screw $\phi$ 4.5mm Length 130mm Thread Length 70mm	1
7	113100007	Depth Gauge for screws $\phi$ 4.5/ $\phi$ 6.5mm Length 110mm	1
8	113100008	Plate Bender Length 285mm	2
9	113100010	Bending Template, large Length 212mm Width 12mm	1
10	113100011	Bending Template, small Length 121mm Width 12mm	1
11	113100012	Double Drill Guide $\phi$ 3.2mm	1
12	113100014	Universal Drill Guide, $\phi$ 4.5/ $\phi$ 3.2mm	1
13	113100015	Universal Drill Guide, $\phi$ 6.5/ $\phi$ 3.2mm	1
14	113100020	Countersink Length 180mm	1
15	114110015	Screwdriver shaft with quick coupling, hexagonal Length 100mm SW3.5	1
16	114400007	Holding Sleeve, $\phi$ 8mm Length 120mm	1
17	113200002	$\phi$ 4.3mm Threaded Drill Sleeve	2
18	113200003	$\phi$ 4.3mm Drill Bit Length 220mm Thread Length 84mm	2
19	113200004	Easyout Length 80mm	2
20	113200005	Direct Measuring Device	1
21	113200009	Screw Driver Length 248mm	1
22	113200010	Stardrive Screwdriver Shaft	1
23	113200011	Holding Sleeve $\phi$ 6.3	1
24	113200038	Torque Limiter 4-5N	1
25	113210001	$\phi$ 2.5 K-Wire	4
26	113210002	$\phi$ 5.8 Cannulated drill bit	2
27	113210004	$\phi$ 5.8mm Cannulated drill sleeve	2
28	113210005	Guide for K-Wire $\phi$ 2.5mm	2
29	113200036	Drill Guide	1
30	113127000	Instruments Tray	1
31	113105000	Screws Tray	1



# Universal Trauma Instrument Set 113129000

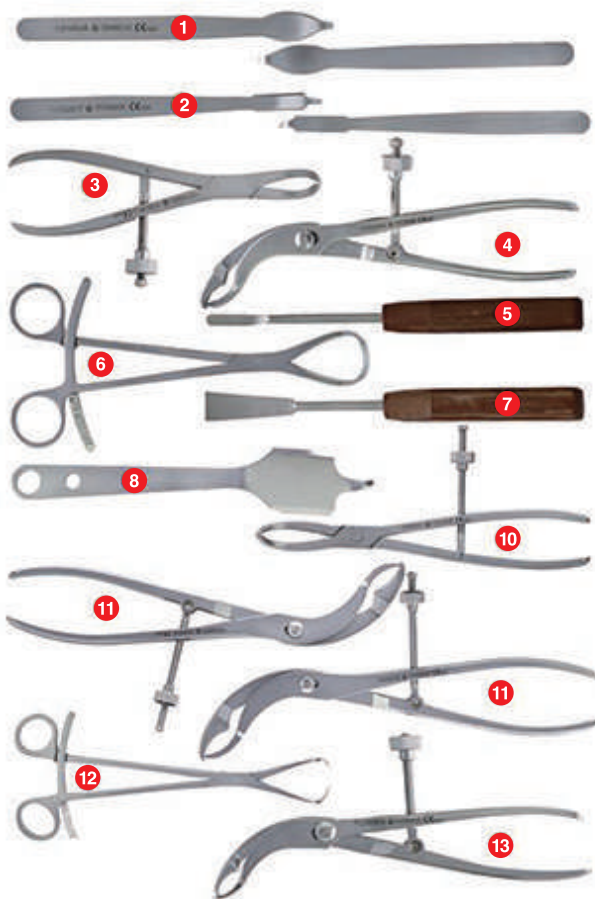
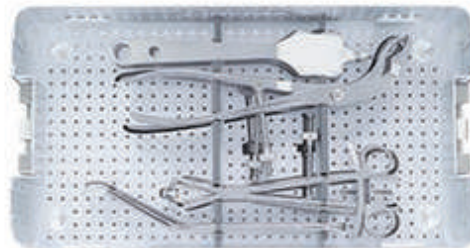

Number	P.N	Name	Quantity
1	112100006	Hohmann Retractor, large Length 159mm Width 15.5mm	2
2	112100007	Hohmann Retractor, small Length 170mm Width 10.5mm	2
3	112100010	Self-Centering Bone Holding Forceps, speed lock Length 191.8mm	1
4	112100011	Reduction Forceps, with serrated jaws Length 158mm	1
5	112100012	Periosteal Elevator,small Length 190mm	1
6	112100013	Reduction Forceps, with points Length 192mm	1
7	113100016	Periosteal Elevator,large Length 191mm	2
8	113100017	Hohmann Retractor, large Length 267mm Width 43.5mm	2
9	113100018	Hohmann Retractor, small Length 267mm Width 16mm	1
10	113100019	Self-Centering Bone Holding Forceps, speed lock Length 286mm	1
11	113100021	Reduction Forceps, with serrated jaws Length 220mm	1
12	113100022	Reduction Forceps, with point Length 207mm	1
13	112200012	Self-Centering Bone Holding Forceps(compression)	1
14	113122000	Instruments Tray	1

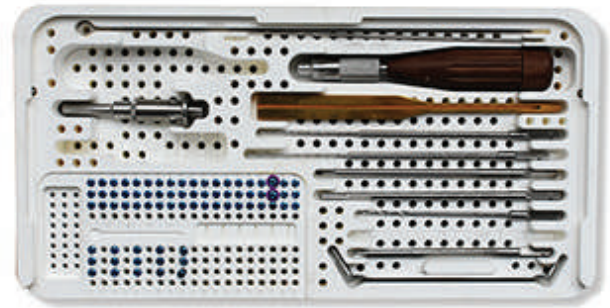
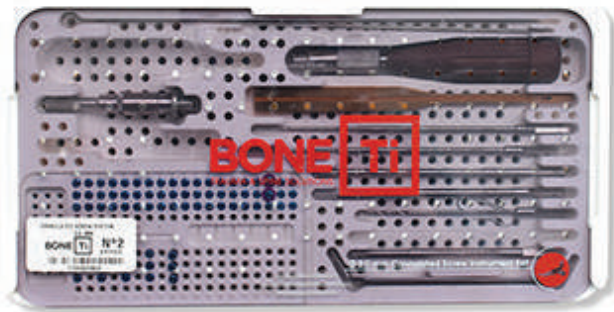

Number	P.N	Name	Quantity
1	114500001	Kirschner (Ø1.1)	4
2	114500002	K-Wire with Threaded Tip (Ø1.1)	4
3	114500003	Drill Sleeve(1.1/2.0)	1
4	114500004	Cannulated T-handle with Quick Coupling	1
5	114500005	Depth Gauge	1
6	114500006	Cannulated drill bit	2
7	114500007	Countersink	1
8	114500008	Cannulated Phillips Screwdriver	1
9	114500009	Phillips Solid Screwdriver	1
10	114500010	Cleaning Wire	1
11	114500011	Screw Holder	1
12	112300003	Ø2.0 Drill Bit	1
13	114502000	Instruments tray	1



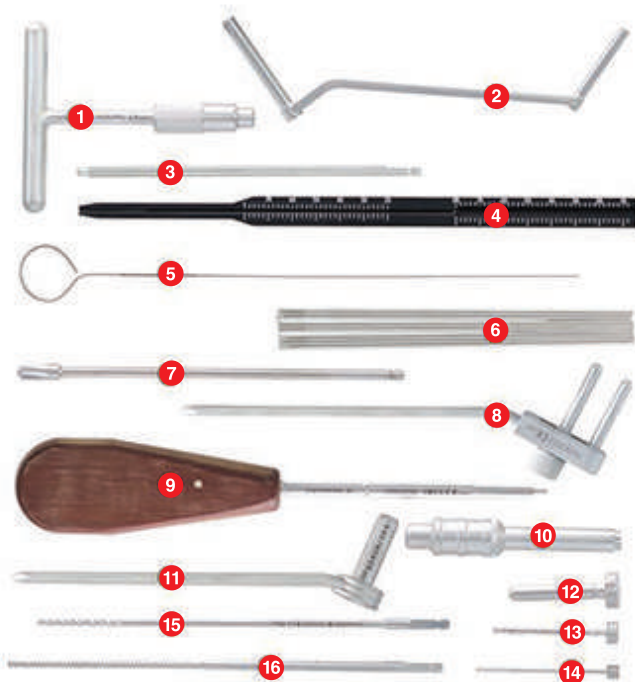
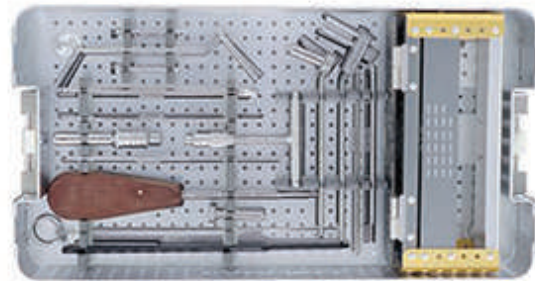

Number	P.N	Name	Quantity
1	112100024	T-handle with Quick Coupling Length 90mm	1
2	113100013	Universal Drill Guide Ø4.5/3.2mm	1
3	114110015	Screwdriver shaft with quick coupling, hexagonal Length 100mm SW3.5	1
4	114200001	Depth Gauge Length 150mm/230mm	1
5	114200002	φ1.6mm Cleaning Wire Length 240mm	1
6	114200003	φ1.6mm Kirschner Wire Length 150mm Thread Length 11mm	10
7	114200004	Countersink Drill Bit Length 160mm	1
8	114200005	Parallel Locator φ1.6mm	1
9	114200006	SW3.5 Hexagonal Screwdriver	1
10	114200007	φ6.5 Holding Sleeve Length 89mm	1
11	114200008	φ9.5/φ7.0Locator Length 39mm	1
12	114200009	φ7.0/φ3.2Drill bushing Length 46mm	1
13	114200010	φ3.2/φ1.6Drill bushing Length 52mm	1
14	114200011	φ1.6Trocar Length 58.8mm	1
15	114200012	φ3.2Cannulated Drill Bit Length 170mm	1
16	114200014	Cannulated Tap for Cancellous Bone screws φ4.5mm Length 180mm Thread Length 80mm	1
17	114202000	Screw Tray	1
18	114204000	Instrument Tray( CanNUS-4.5)	1

# HB6.5/7.3 Cannulated Screw System

## CanNUS™ 114409000

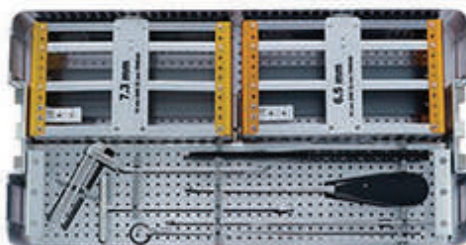

Number	P.N	Name	Quantity
1	114400001	Depth Gauge Length 330mm	1
2	114400002	φ2.5mm Cleaning Wire Length 330mm	1
3	114400003	φ2.5mm Kirschner wire Length 300mm Thread Length 15mm	10
4	114400004	φ5mm Drill Bit Length 300mm	1
5	114400005	Parallel Locator	1
6	114400006	SW4.0Hexagonal Screwdriver Length 248mm	1
7	114400007	Holding Sleeve, φ8mm Length 120mm	1
8	114400008	φ2.5mm Trochar Length 128mm	1
9	114400009	φ8.5/φ2.5Drill Bushing Length 118mm	1
10	114400010	φ12/φ8.5Protective Sleeve Length 108mm	1
11	114400011	Hexagonal Solid Screwdriver Length 248mm	1
12	114400012	φ8Tubular Countersink Drill Length 230mm	1
13	114400014	Adjustable Parallel Drill Guideφ2.5mm	1
14	114400015	Tap for Cancellous Bone Tubular Screw Length 280mm Thread Length 40mm	1
15	114404000	Instrument Tray	1
16	114402000	Screw Tray HB6.5	1
17	114403000	Screw Tray HB7.5	1



# Proximal Femoral Nail System CanPFN™ 11549000

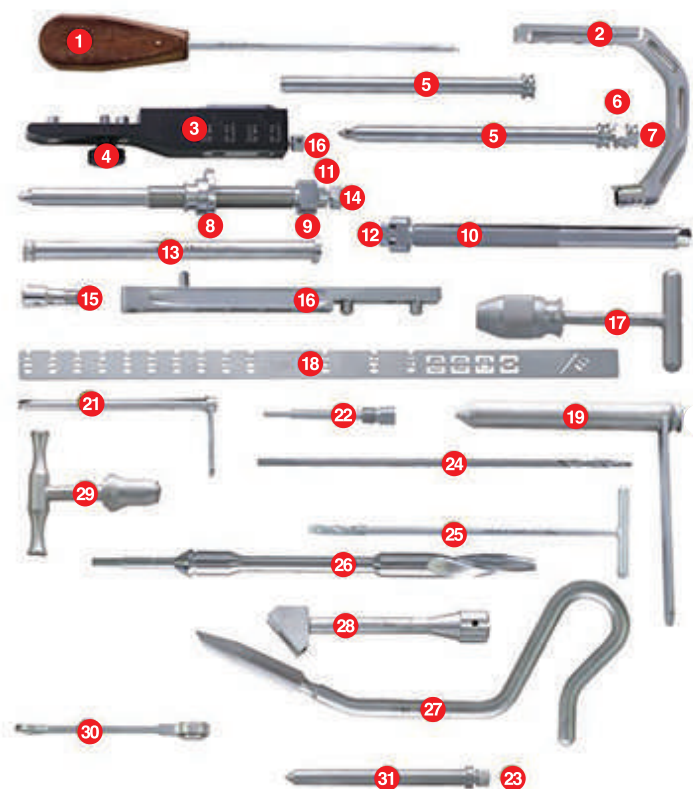
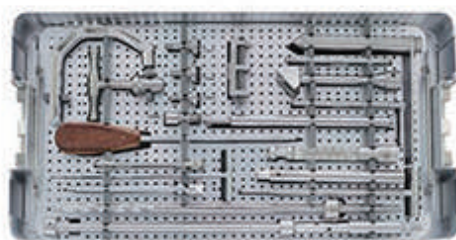

Number	P.N	Name	Quantity
1	114400011	Hexagonal Solid Screwdriver Length 248mm	1
2	115400001	Insertion Handle	1
3	115400002	Proximal Aiming Arm	1
4	115400003	Buttress Nut for Proximal Aiming Arm	3
5	115400004	Protection Sleeve for distal locking	1
6	115400005	Obturator for Distal Locking	2
7	115400006	Trocar for Distal Locking	2
8	115400007	Compression Nut	1
9	115400008	Protection Sleeve for blade	1
10	115400009	Protection Sleeve for lag screw	1
11	115400010	Obturator for Blade	1
12	115400011	Obturator for Lag Screw	1
13	115400012	Protection Sleeve for lag screw	1
14	115400013	Trocar	1
15	115400014	Connecting Nut	1
16	115400015	Aiming Arm for distal locking	2
17	115400016	Distal Aiming Connecting Shaft	1
18	115400017	Distal Targeting Device for Long Nail	1
19	115400018	Targeting Device Nut for Long Nail	1
20	115400019	Drill Sleeve	1
21	115400020	Ø5.2 Protection Drill Sleeve	1
22	115400021	Temporary End Cap for the lag screw	1
23	115400022	Obturator	1
24	115400023	Ø5.2 Drill Bit	1
25	115400024	Flat Drill with T-Handle	1
26	115400025	Proximal Reamer	2
27	115400027	Awl	1
28	115400029	Impactor	2
29	115400030	Quick Connection T-Handle	2
30	115400031	Ratchet Wrench for Nut, hexagonal	1
31	115400032	Slotted Hammer	1



Number	P.N	Name	Quantity
32	115400033	Guide Wire Ø3.2×400	1
33	115400034	Depth Gauge for Guide Wire Ø3.2	1
34	115400035	Cannulated Drill Bit for cortex bone Ø10.6/Ø3.2	1
35	115400036	Cannulated Drill Bit with limit Ø10.6/Ø3.2	1
36	115400037	Fixation Sleeve SW4.5/φ3.2	1
37	115400038	Screwdriver for PFN Blade	1
38	115400039	Extractor Connection shaft for blade	1
39	115400040	Counter-torque Wrench for blade	1
40	115400041	φ4.3 Drill Bit φ4.3/300mm	1
41	115400043	Pin Wrench SW3/SW5	1
42	115400044	Depth Gauge for Locking screw	1
43	115400045	Screwdriver, hexagonal SW3.5	1
44	115400046	Wrench with T-Handle	1
45	115400047	Extractor for Nail M8	1
46	115400048	Guide Wire with Hook φ2.8	1
47	115400049	Cannulated Screwdriver for end cap φ2.8/SW4/SW11	1
48	115400050	Cannulated Wrench for end cap SW11	1
49	115400051	Extractor for Blade SW4.5/φ3.2	1
50	115400052	Cleaning Wire	1
51	115400053	Lag-Screw Holding shaft	1
52	115400054	Wrench shaft for Lag Screw	1
53	115400055	Distal Aiming Connecting Shaft	1
54	115400056	Distal Targeting Device for Long Nail	1
55	115400057	Targeting Device Nut for Long Nail	1
56	115400058	Distal Outrigger	1
57	115400059	Distal Outrigger Nut for Long Nail	1
58	115400060	U-shaped Stabilizing Spacer	1
59	115400061	Location Shaft	1
60	115400062	Location Sleeve	1
61	115400063	Handle Connecting Nut	1
62	115403000	Instrument Tray	1



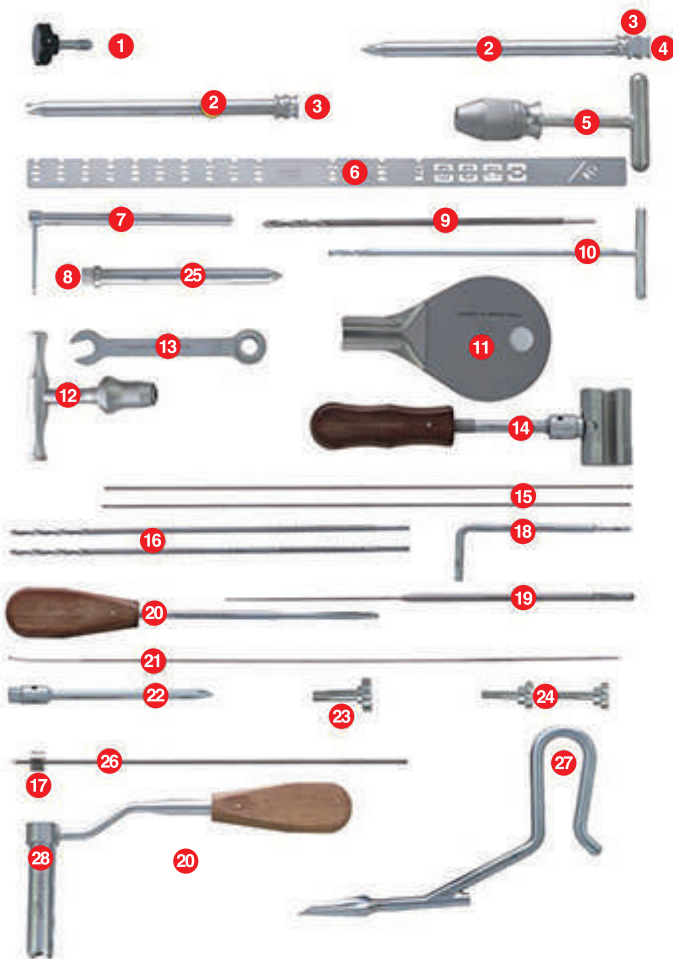

Number	P.N	Name	Quantity
1	115400003	Buttress Nut for Proximal Aiming Arm	1
2	115400004	Protection Sleeve for distal locking	2
3	115400005	Obturator for Distal Locking	2
4	115400006	Trocar for Distal Locking	1
5	115400016	Universal Chunk with T-Handle	1
6	115400017	Radiographic Ruler	1
7	115400020	Ø5.2Protection Drill Sleeve	1
8	115400022	Obturator	1
9	115400023	Ø5.2Drill Bit	1
10	115400024	Flat Drill with T-Handle	1
11	115400026	Tissue Protector	1
12	115400030	Quick Connection T-Handle	1
13	115400031	Ratchet Wrench for Nut, hexagonal	1
14	115400032	Slotted Hammer	1
15	115400033	Guide Wire Ø3.2×400	2
16	115400041	φ4.3 Drill Bitφ4.3/300mm	2
17	115400042	φ4.5 Drill Stop φ4.3/SW3	1
18	115400043	Pin Wrench SW3/SW5	1
19	115400044	Depth Gauge for Locking screw	1
20	115400045	Screwdriver,hexagonal SW3.5	1
21	115400048	Guide Wire with Hook φ2.8	1
22	115400049	Cannulated Screwdriver for end cap φ2.8/SW4/SW11	1
23	115400057	Targeting Device Nut for Long Nail	1
24	115400059	Distal Outrigger Nut for Long Nail	2
25	115400062	Location Sleeve	1
26	115400063	Handle Connecting Nut	1
27	115500001	Cannulated Awl	1
28	115500002	Protection Sleeve	1

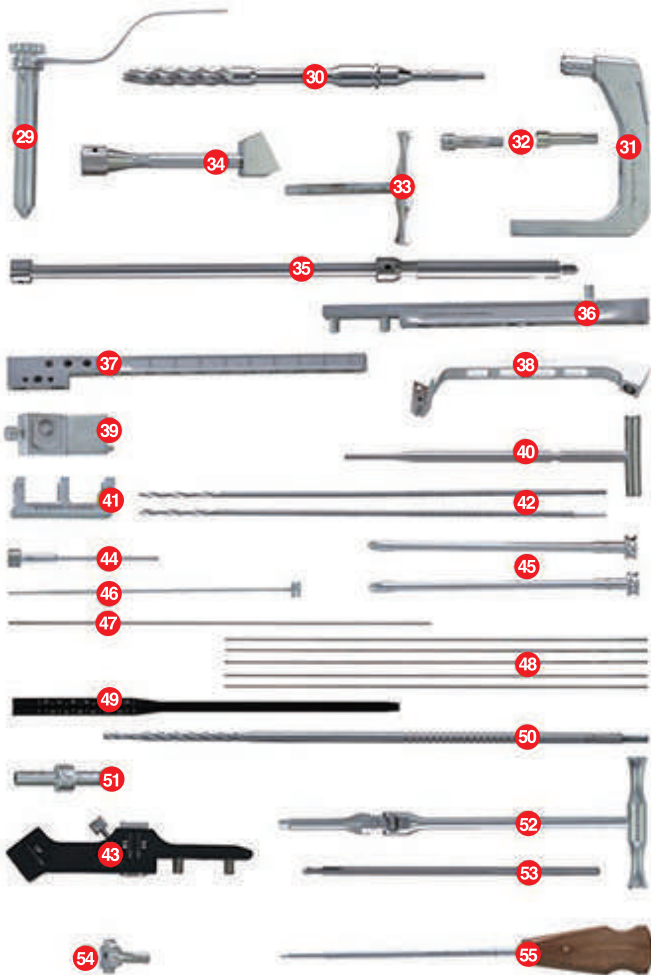

Number	P.N	Name	Quantity
29	115500003	Location Sleeve	1
30	115500004	Proximal Cannulated Drill bit	1
31	115500005	Obturator for Distal Locking	1
32	115500006	Trocar for Distal Locking	2
33	115500007	Wrench for Connecting Nut	1
34	115500008	Impactor for Nail	1
35	115500009	Extract shaft for Nail	1
36	115500010	Proximal location shaft	1
37	115500012	Distal location shaft	1
38	115500014	Distal Outrigger	1
39	115500015	Distal location block	1
40	115500017	Location shaft	1
41	115500018	Location shaft	1
42	115500019	Drill Bit	2
43	115500022	Obturator	1
44	115500024	Flat Drill with T-Handle	1
45	115500025	Guide wire Sleeve	2
46	115500026	Tissue Protector	1
47	115500027	Guide Wire	2
48	115500028	Guide Wire Ø2.5mm, with threaded tip	4
49	115500029	Depth Gauge for Guide Wire	1
50	115500030	Cannulated drill bit	1
51	115500031	Drill stop	1
52	115500032	Universal Wrench with T-Handle	1
53	115500033	SW4.0 Screw shaft for end cap	1
54	115500034	Ø4.2 Guide Wire	1
55	115500035	Hexagonal Solid Screwdriver	1
56	115502000	Instrument Tray	1



# Proximal Femoral Nail System CanEFN™ 115509000

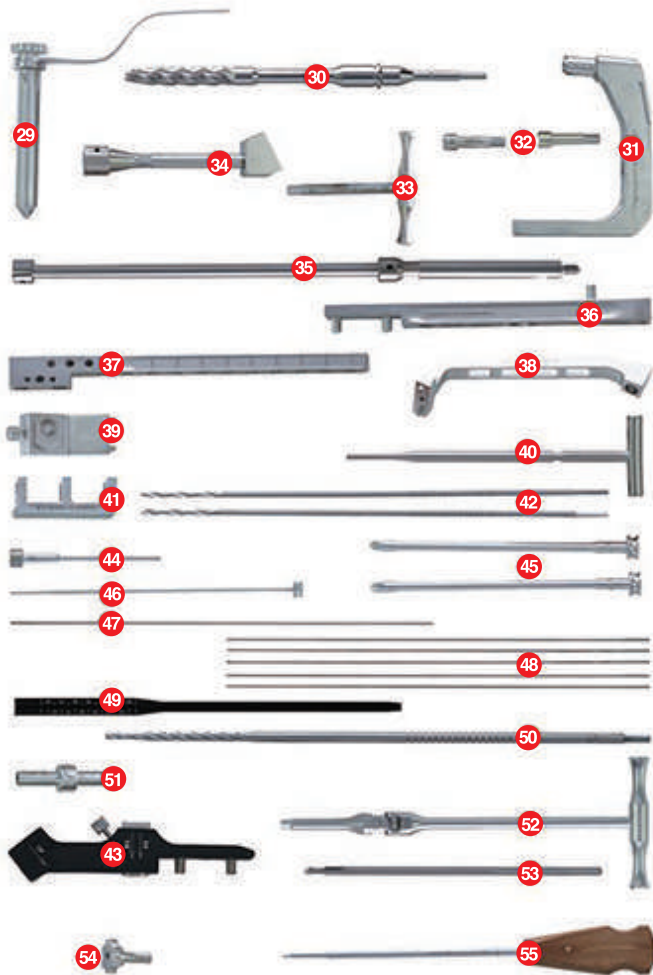

Number	P.N	Name	Quantity
29	115500003	Location Sleeve	1
30	115500004	Proximal Cannulated Drill bit	1
31	115500005	Obturator for Distal Locking	1
32	115500006	Trocar for Distal Locking	2
33	115500007	Wrench for Connecting Nut	1
34	115500008	Impactor for Nail	1
35	115500009	Extract shaft for Nail	1
36	115500010	Proximal location shaft	1
37	115500012	Distal location shaft	1
38	115500014	Distal Outrigger	1
39	115500015	Distal location block	1
40	115500017	Location shaft	1
42	115500019	Drill Bit	2
43	115500022	Obturator	1
44	115500024	Flat Drill with T-Handle	1
45	115500025	Guide wire Sleeve	2
46	115500026	Tissue Protector	1
47	115500027	Guide Wire	2
48	115500028	Guide Wire Ø2.5mm, with threaded tip	4
49	115500029	Depth Gauge for Guide Wire	1
50	115500030	Cannulated drill bit	1
51	115500031	Drill stop	1
52	115500032	Universal Wrench with T-Handle	1
53	115500033	SW4,0 Screw shaft for end cap	1
54	115500034	Ø4.2 Guide Wire	1
55	115500035	Hexagonal Solid Screwdriver	1
56	115503000	Instrument Tray	1

# Tibia Nail System CanTN™ 115709000

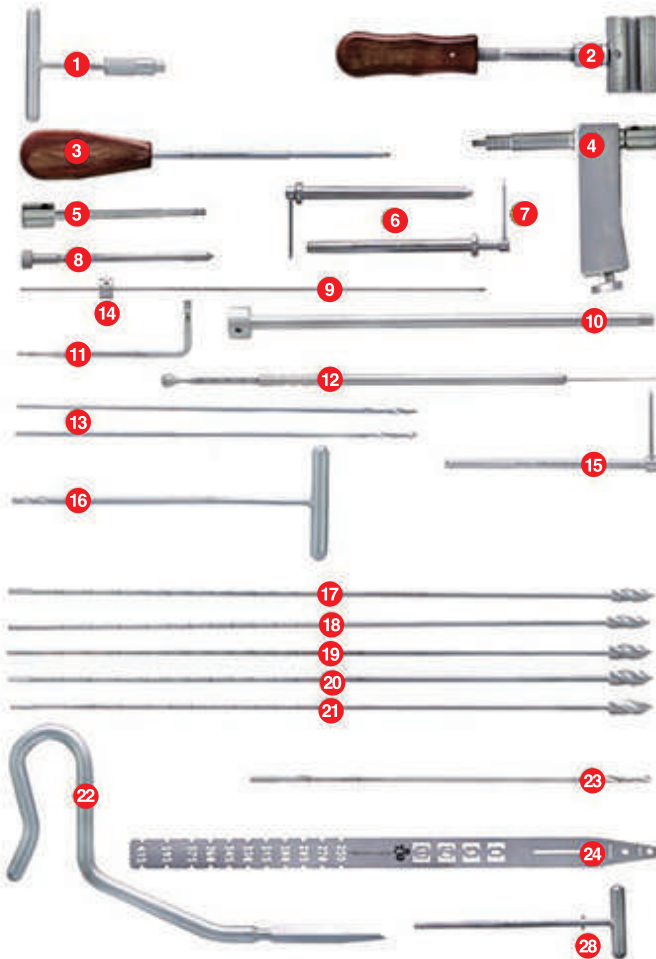
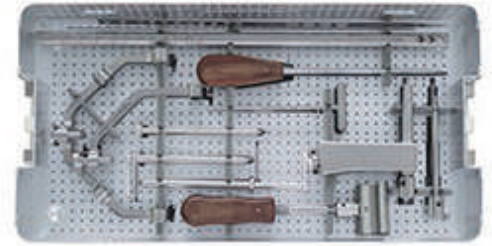

Number	P.N	Name	Quantity
1	112100024	T-handle with Quick Coupling Length 90mm	1
2	115400032	Slotted Hammer	1
3	115400045	Screwdriver,hexagonal SW3,51	1
4	115700001	Tibia Nail Targeting Device	1
5	115700021	Locking Bolt	1
6	115700002	Protection Sleeve	2
7	115700003	Drill Sleeve	2
8	115700004	Obturator	1
9	115700005	Location Pin	1
10	115700007	Insertor / Extractor for Tibia Nail	1
11	115700008	Wrench	1
12	115700009	Depth Gauge	1
13	115700010	Ø3.2 Drill Bit, Length 28mm	2
14	115700011	Drill stop	1
15	115700012	Ø7/Ø5 Drill Sleeve	1
16	115700013	Flat Drill with T--Handle	1
17	115700014	Ø7 Reamer	1
18	115700015	Ø8 Reamer	1
19	115700016	Ø9 Reamer	1
20	115700017	Ø10 Reamer	1
21	115700018	Ø11 Reamer	1
22	115700019	Three-fluted Awl	1
23	115700020	Ø5 Drill Bit	1
24	115710001	Radiographic Ruler	1
29	115703000	Instrument Tray	1



# Tibia Nail System CanETN™ 115719000

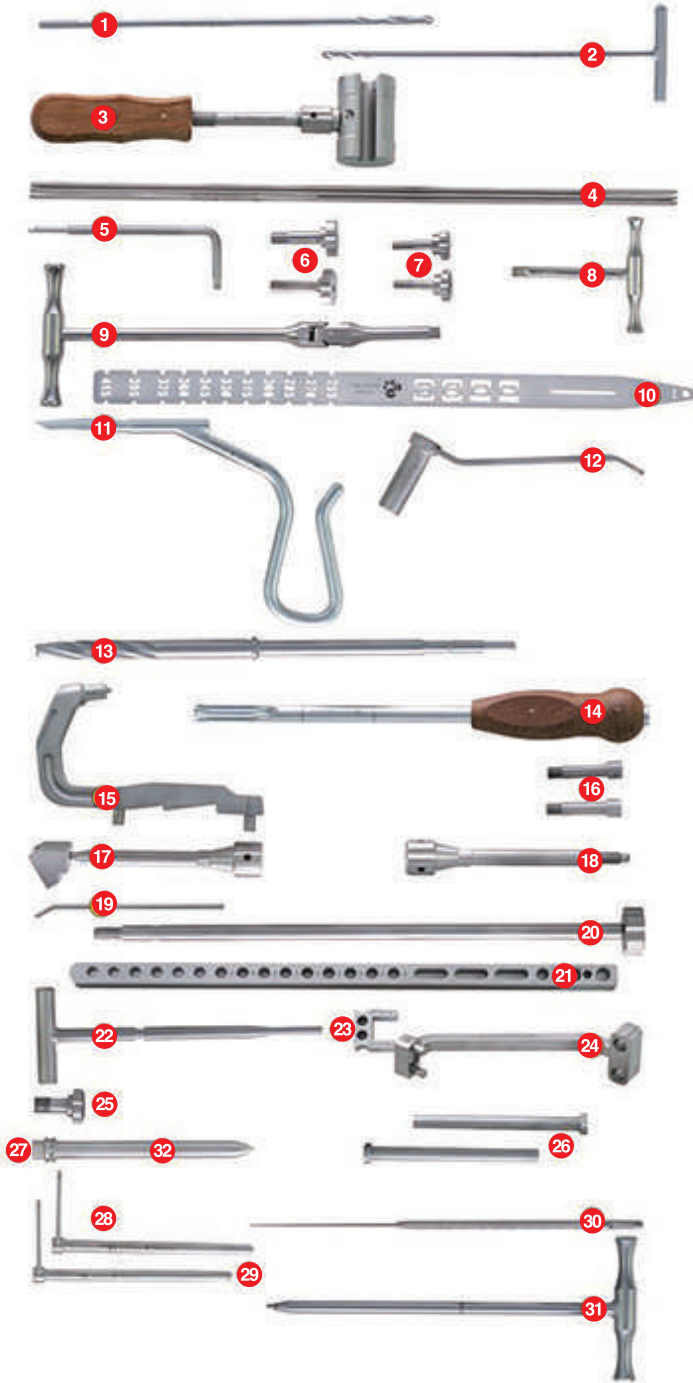
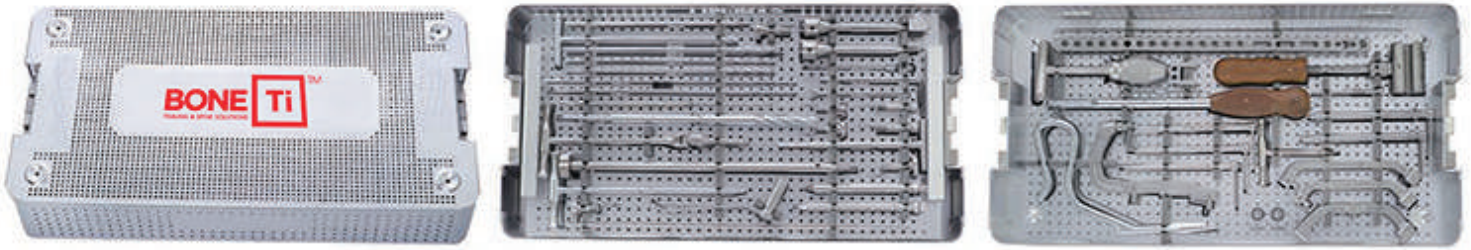

Number	P.N	Name	Quantity
1	115400023	Ø5.2Drill Bit	1
2	115400024	Flat Drill with T-Handle	1
3	115400032	Slotted Hammer	1
4	115400033	Guide Wire Ø3.2×400	3
5	115400043	Pin Wrench SW3/SW5	1
6	115400057	Targeting Device Nut for Long Nail	2
7	115400059	Distal Outrigger Nut for Long Nail	2
8	115500007	Wrench for Connecting Nut	1
9	115500032	Universal Wrench with T-Handle	1
10	115710001	Radiographic Ruler	1
11	115710002	Canulated Awl	1
12	115710003	Protection Sleeve	1
13	115710004	Canulated Drill Bit	1
14	115710005	Canulated Hole Punch	1
15	115710007	Insertion Handle	1
16	115710008	Connecting Nut	2
17	115710009	Driving Cap with Handle Adaptor	1
18	115710034	Extractor for Nail	1
19	115710010	Pin Wrench	1
20	115710011	Hammer Guide	1
21	115710012	Shaft	1
22	115710013	Location Shaft	1
23	115710014	Stabilization Spacer	1
24	115710015	Distal Outrigger	1
25	115710016	Distal Outrigger Nut	1
26	115710017	Protection Sleeve	2
27	115710018	Obturator	1
28	115710019	Protection Drill Sleeve(φ4.3)	2
29	115710020	Protection Drill Sleeve(φ3.2)	2
30	115710021	Depth Gauge	1
31	115710022	T-handle	1
32	115710023	Proximal Arming Arm	1

# Tibia Nail System CanETN™ 115719000



Number	P.N	Name	Quantity
33	115710024	Proximal Aiming Arm for Cancellous Bone	1
34	115710025	Protection Sleeve	1
35	115710026	Drill Sleeve	1
36	115710027	Trocar	1
37	115710028	Drill Bit (Φ3.2×250)	1
38	115710029	Compression Bolt	1
39	115710030	Plug for End Cap	1
40	115710031	Drill Bit (Φ4.3×250)	1
41	115710032	Drill Bit (Φ4.3×300)	1
42	115710033	Drill Bit (Φ3.2×300)	1
43	115710035	Φ3.2 Drill Sleeve	1
44	115712000	Instruments Tray(CanETN)	1



# Sternoclavicular Hook System CanSHS™ 112129000

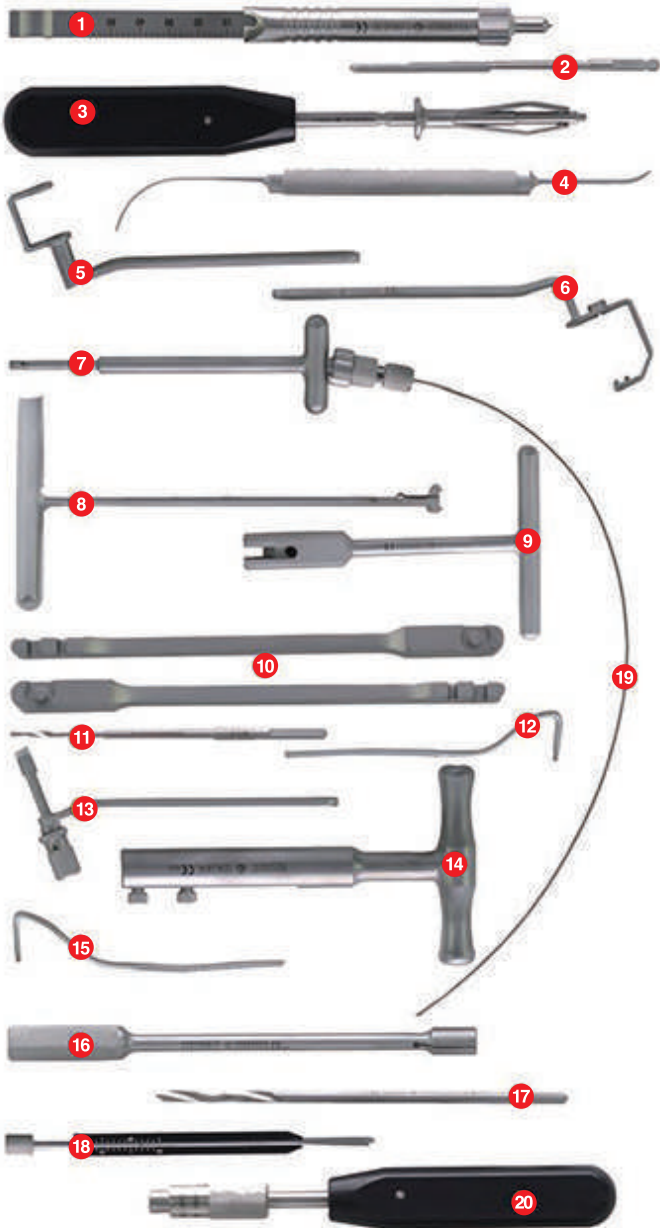
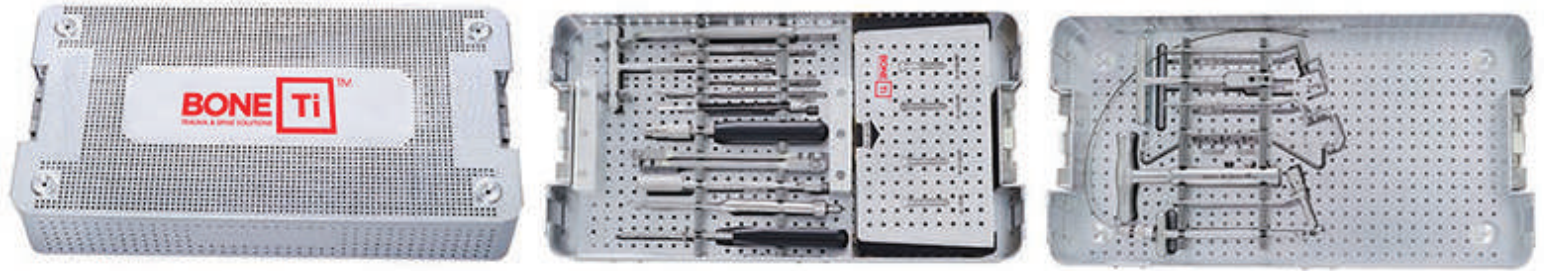

Number	P.N	Name	Quantity
1	112100001	Depth Gauge for $\phi 2.5\text{mm}-\phi 4.0\text{mm}$ Length 60mm	1
2	112100018	Tap for Cortex Screw $\phi 3.5\text{mm}$ Length 112mm Thread Length 30mm	1
3	112100022	Tap for Cortex Screw $\phi 3.5\text{mm}$ Length 112mm Thread Length 30mm	1
4	112120001	Periosteal Elevator	1
5	112120002	Drill Guider Height 20mm Inner diameter 4.0mm	1
6	112120003	Cable Guider Height 36mm	1
7	112120004	Guidance Screwdriver	1
8	112120005	Upper Gasket Wrench T-Type Length 150mm	1
9	112120006	Wrench T -Type Length 124mm	1
10	112120007	Plate Bender Length 170mm	2
11	112120008	$\phi 2.5$ Drill Bit Length 112mm	1
12	112120009	Template with screw head, right	1
13	112120010	Drilling deep limiter	1
14	112120011	Radial reverse wrench Length 145mm	1
15	112120012	Template with screw head, left	1
16	112120013	Crosslink Nut Driver Length 150mm	1
17	112120014	Drill Bit, $\phi 4.2\text{mm}$ Length 145mm Thread Length 48mm	1
18	112120015	Sternum depth Gauge Length 30mm	1
19	112120016	Instruments Tray	2
20	211010015	Guide wire	1
21	112123000	Instruments Tray	1
22	112204000	Screw Tray	1



# Less Invasive Stabilization System Instruments set CanLISS 113409000

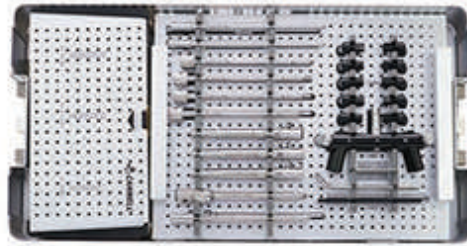

Number	P.N	Name	Quantity
1	113200009	Screw Driver Length 248mm	1
2	113200038	Torque Limiter 4.5N	1
3	113400001	Drill Bit(Φ4.3)	2
4	113400002	Threaded Drill Sleeve	2
5	113400003	Drill Shaft	1
6	113400004	Hole Stopper	10
7	113400005	Insertion Sleeve	3
8	113400006	Kirschner Wire Insertion Sleeve	1
9	113400007	Trocar	1
10	113400008	Wrench Shaft	1
11	113400009	Pull Reduction Instrument	1
12	113400010	Kirschner Wire Insertion Sleeve	2
13	113400011	Fixation Bolt	1
14	113400012	Stabilization Bolt	2
15	113400013	K-wire Aiming Attachment	1
16	113400014	Cleaning Instrument for Screw Head	1
17	113400015	X-Ray Calibrator	2
18	113400016	K-Wire with Threaded Tip	4
19	113400017	K-Wire Measuring Instrument	1
20	113400018	K-Wire Measuring Instrument	1
21	113400019	Insertion Guide for Distal Lateral Femur, Right	1
22	113400020	Insertion Guide for Distal Lateral Femur, Left	1
23	113400022	Depth Gauge	1
24	113400023	Insertion Guide for Proximal Tibia, Right	1
25	113404000	Instruments Tray	1
26	113403000	Screw Tray(CanLISS)	1



# Dynamic Hip and Condylar System CanDHS™ / CanDCS™ 114119000

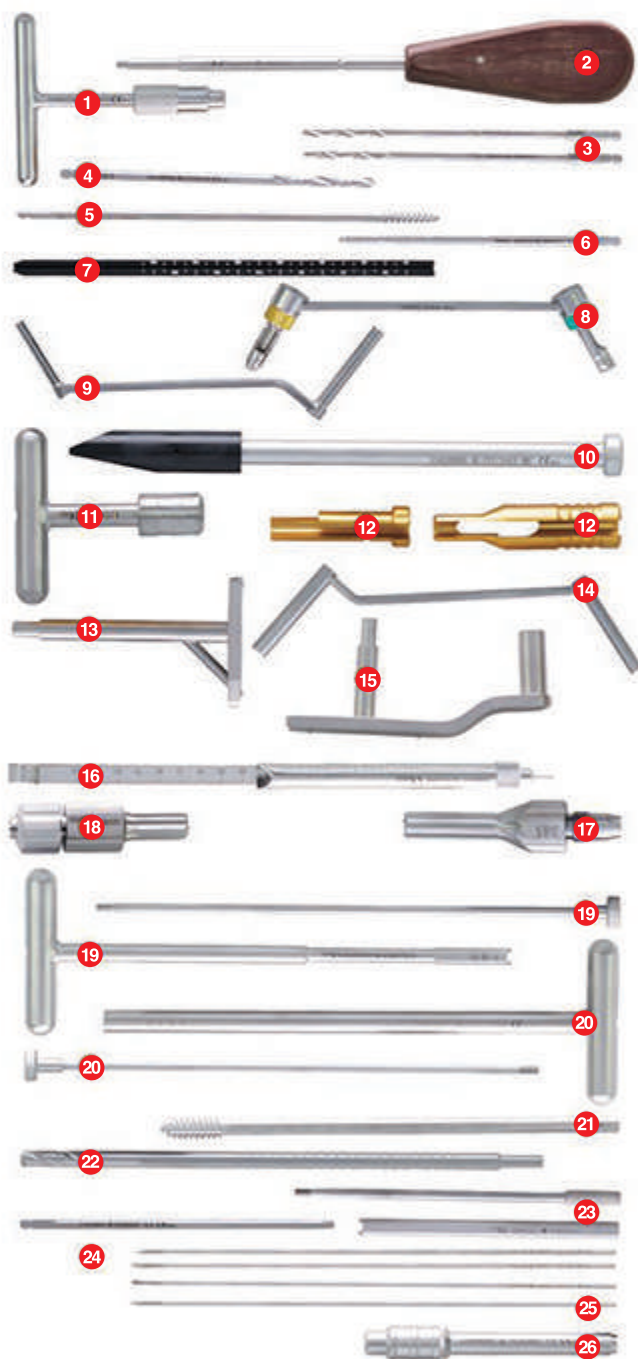
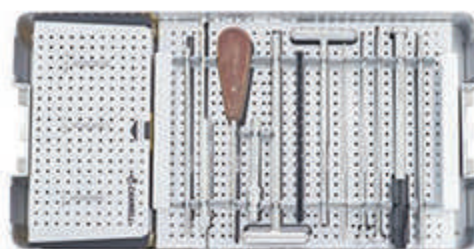

Number	P.N	Name	Quantity
1	112100024	T-handle with Quick Coupling Length 90mm	1
2	113100001	Hexagonal Screwdriver, Length 248mm	1
3	113100002	Drill Bit, $\phi$ 3.2mm Length 147mm Thread Length 40mm	2
4	113100003	Drill Bit, $\phi$ 4.5mm Length 145mm Thread Length 48mm	1
5	113100005	Tap for Cancellous Bone Screw $\phi$ 6.5mm Length 195mm Thread Length 26mm	1
6	113100006	Tap for Cortex Screw $\phi$ 4.5mm Length 130mm Thread Length 70mm	1
7	113100007	Depth Gauge for screws $\phi$ 4.5/ $\phi$ 6.5mm Length 110mm	1
8	113100012	Double Drill Guide $\phi$ 3.2mm	1
9	113100013	Universal Drill Guide $\phi$ 4.5/ $\phi$ 3.2mm	1
10	114110001	CanDHS / DCS Impactor	1
11	114110002	T-Handle with Quick Coupling, for taps and drill guides	1
12	114110003	Centering Sleeve	1
13	114110004	CanDHS™ Angled Guide, 135°	1
14	114110005	Double Drill Guide $\phi$ 6.5 / 4.5mm	1
15	114110006	CanDCS™ Angled Guide, 95°	1
16	114110007	Depth Gauge	1
17	114110008	CanDHS Reamer	1
18	114110009	CanDCS Reamer	1
19	114110010	T-Lag Screw Wrench, for insertion	1
20	114110011	T-Lag Screw Wrench, for insertion and removal	1
21	114110012	Tap for CanDHS / DCS Screws	1
22	114110013	Drill Bit, $\phi$ 8.0mm	1
23	114110014	Connecting Screw with Guide Shaft	1
24	114110015	Screwdriver shaft with quick coupling, hexagonal Length 100mm SW3.5	1
25	114110016	Guide Wire $\phi$ 2.5mm, with threaded tip, length 230mm	4
26	114400007	Holding Sleeve, $\phi$ 8mm Length 120mm	1
27	114113000	Instruments Tray	1
28	113204000	Screw Tray	1





Number	P.N	Name	Quantity
1	114110015	Screwdriver shaft with quick coupling, hexagonal Length 100mm SW3.5	1
2	112110001	Universal Hexagonal Wrench Length 346.5mm	1
3	112110002	Extended Hexagonal Wrench Length 294mm	1
4	112110004	Drill Bit, $\phi$ 3.2mm Length 225mm Thread Length 63mm	1
5	112110005	Drill Bit, $\phi$ 2.5mm Length 234mm Thread Length 60mm	1
6	112110006	Soft Drill, $\phi$ 2.5mm Length 245mm Thread Length 60mm	1
7	112110007	Periosteal Elevator, large Length 300mm Width 21mm	1
8	112110008	Periosteal Elevator, small Length 300mm Width 15mm	1
9	112110009	Plate Bender Wrench	1
10	112110010	Tap for Cancellous Bone Screw $\phi$ 6.5mm	1
11	112110011	Curved Reconstruction Plate Template Length 240mm	1
12	112110012	Straight Reconstruction Plate Template Length 214mm	1
13	112110027	Reset Clamp Sleeve	6
14	112110013	Periosteal Elevator Length 310mm	1
15	112110014	Pelvis single hook Length 260mm	1
16	112110015	Pelvis T-Handle Sharp hook length 213mm	1
17	112110016	Support Tip Length 300mm	1
18	112110017	Reduction Forceps (Large, straight)	1
19	112110018	Reduction Forceps (Large, straight)	1
20	112110019	Reduction Forceps, with 3 Ball Tips	1
21	112110020	Small Farabeuf Forceps (small)	1
22	112110021	Reduction Forceps, Oblique (small)	1
23	112110022	Reduction Forceps, Oblique (large)	1
24	112110023	Reduction Forceps (middle)	1
25	112110024	Reduction Forceps, Oblique (large)	1
26	112110025	Farabeuf Forceps (large)	1
27	112110026	Reset Clamp Sleeve	1
28	211010015	T-Handle with Quick Coupling	1
29	112112000	Instrument Tray	1



# Dynamic reaming Instruments Set 115419000

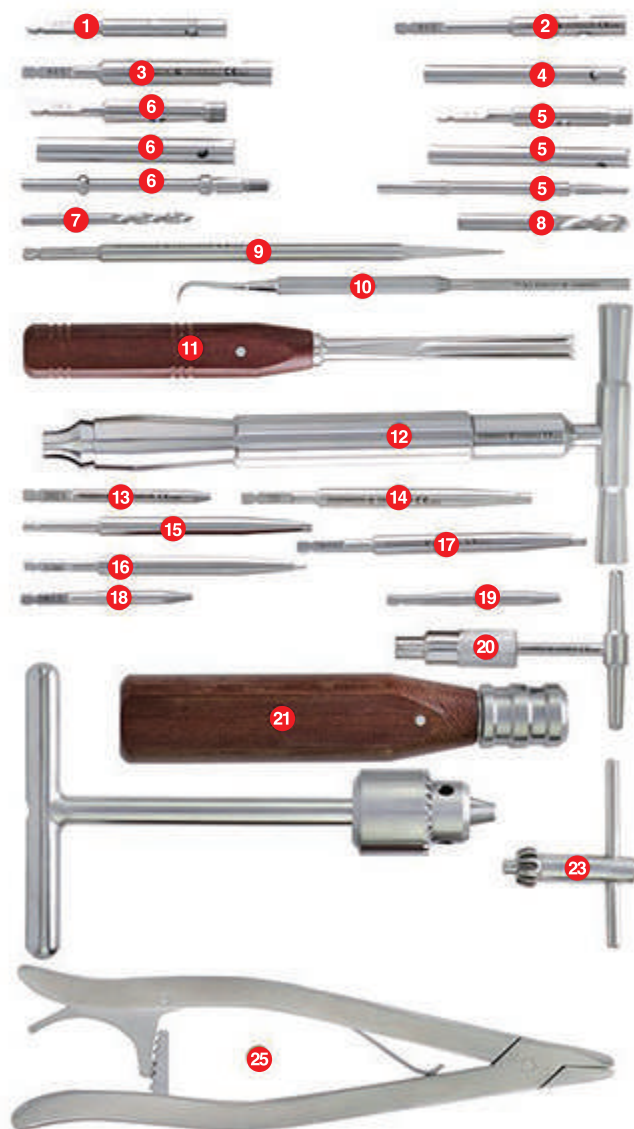
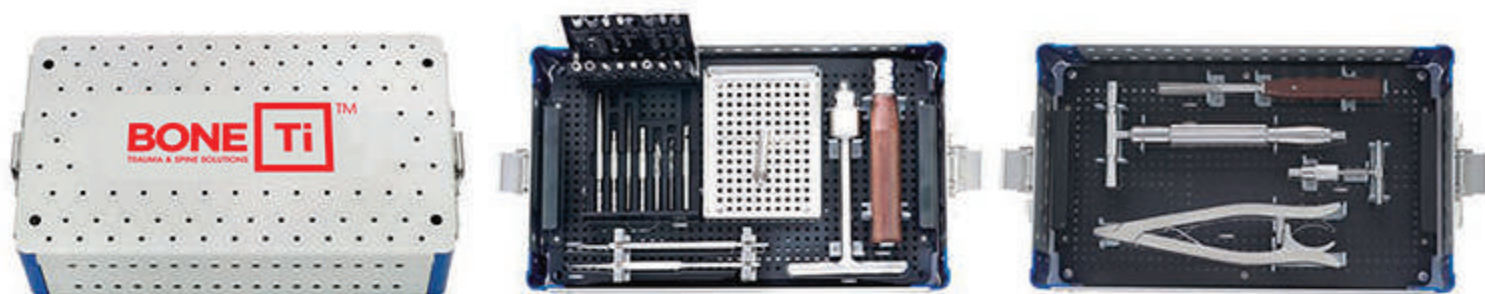

Number	P.N	Name	Quantity
1	113200012	Screw Extractor(Ø3.5)	1
2	113200013	Screw Extractor(Ø4.5)	1
3	113200014	Screw Extractor(Ø6.5)	1
4	113200015	Reamer Tube(Ø3.5)	1
5	113200016	Reamer Tube(Ø4.5)	1
6	113200017	Reamer Tube(Ø6.5)	1
7	113200018	HSS Drill Bit(Ø4.0)	1
8	113200019	HSS Drill Bit(Ø6.0)	1
9	113200020	Awl	1
10	113200021	Sharp Hook	1
11	113200022	Osteotome	1
12	113200023	Broken Screw Extractor	1
13	113200024	Easyout(SW2.5 fine thread)	1
14	113200025	Stardrive Screwdriver shaft(T25)	1
15	113200026	Stardrive Screwdriver shaft(T15)	1
16	113200027	Hexagonal Screwdriver shaft(SW2.5)	1
17	113200028	Hexagonal Screwdriver shaft(SW3.5)	1
18	113200029	Hexagonal Screwdriver shaft(SW3.5)	1
19	113200030	Easyout(SW2.5)	1
20	113200031	Easyout(SW3.5)	1
21	113200032	T-handle with Quick Coupling	1
22	113200033	Straight handle with Quick Coupling	1
23	113200034	Hexagonal Screwdriver shaft(SW4.0)	1
24	113200035	Instrument Box	1
25	212040008	Screw Clamp	1
26	113203000	Instrument Tray(CanSES)	1

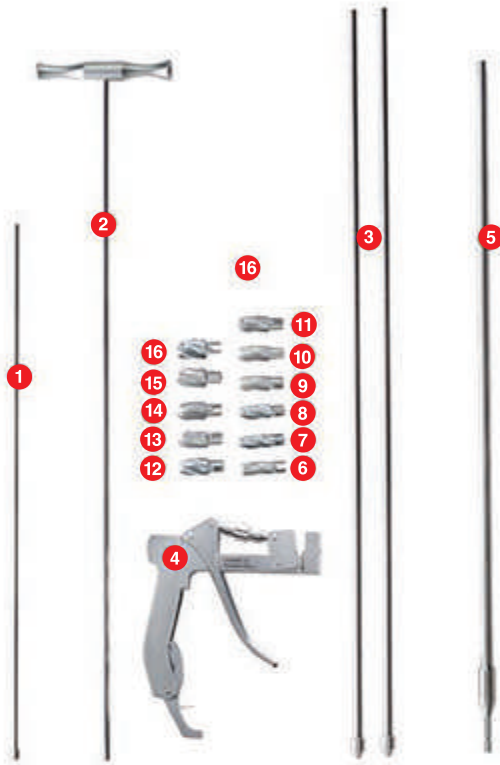

Number	P.N	Name	Quantity
1	115410007	Ball Head Guider	1
2	115410001	Reset Rod with T-Handle	1
3	115410002	Ball Head Guider	2
4	115410003	Extractor for guide Wire	1
5	115410004	Soft Reamer	1
6	115410005	Soft Reamer Head	1
7	115410010	Soft Reamer Head	1
8	115410011	Soft Reamer Head	1
9	115410012	Soft Reamer Head	1
10	115410013	Soft Reamer Head	1
11	115410014	Soft Reamer Head	1
12	115410015	Soft Reamer Head	1
13	115410016	Soft Reamer Head	1
14	115410017	Soft Reamer Head	1
15	115410018	Soft Reamer Head	1
16	115410019	Soft Reamer Head	1





BONE - Ti es una marca Tocamedic Colombia

Carrera 16 No. 13C - 78  
Valledupar - Cesar - Colombia

Tel: (57)(5) 589 85 22

Cel: (57) 310 459 1567

**info@bone-ti.com**

**ventas@tocamedic.com**



@bone.tioficial

**www.bone-ti.com**